

CODESYS

Features and Improvements

CODESYS V3.5 SP16

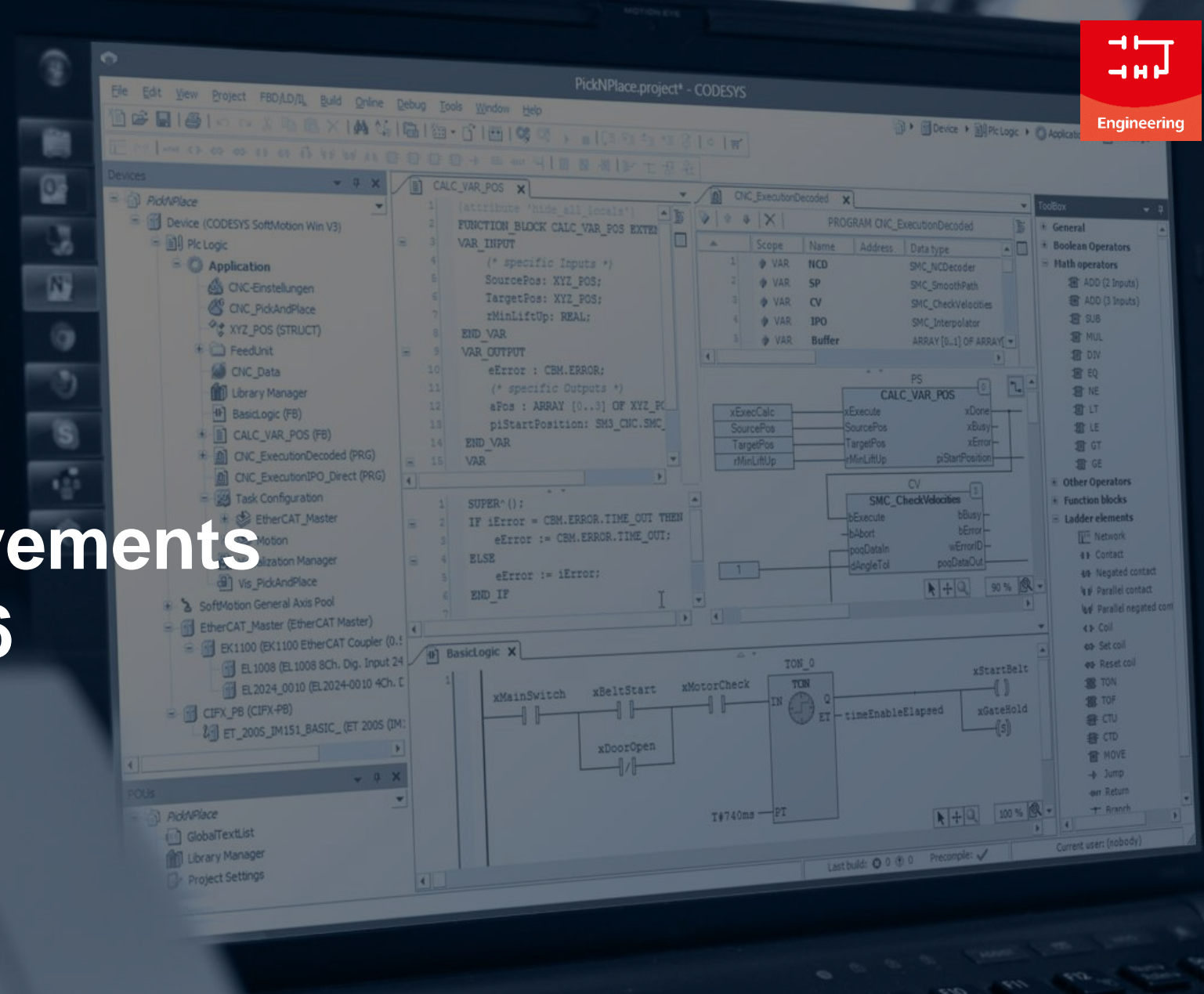

1

Engineering

2

Runtime

3

Visualization

4

Motion CNC Robotics

5

Fieldbus

6

Safety

Overview

- **Device User Management**
- **Integrated web browser**
- **Package Manager**
- **New libraries**
- **New language features**
- **Smart Coding and Usability**
- **Memory consumption in CODESYS**
- **CODESYS Professional Developer Edition**
 - CODESYS Static Analysis: Major improvements
 - CODESYS Profiler
 - CODESYS SVN
 - CODESYS Test Manager
 - CODESYS UML

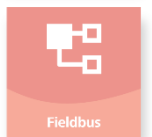
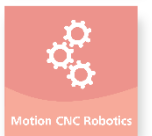
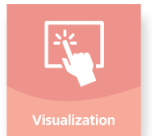

Device User Management

- **Secure, encrypted transmission of user names and passwords**
- **New services: asymmetrical procedure for the transmission of passwords at login**
- **Forwarding of client type to the controller (e.g. CODESYS Development System or CODESYS Automation Server)**
- **Now only possible online: handling of users, passwords, groups**
- **Export/import: Still possible - password required**
- **User Interface: Almost unchanged**
- **Workflows: Slightly different**

**Benefit for CODESYS users:
Secured passwords - even without encrypted communication**

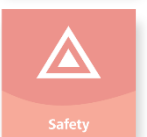
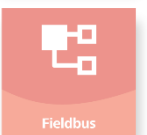
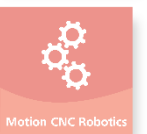
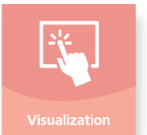
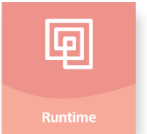
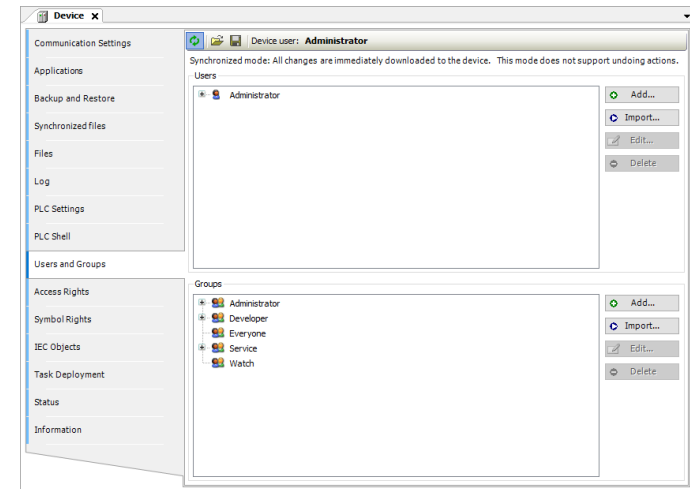

Integrated web browser: Chromium Embedded Framework (CEF)

- **Security update**
- **Used for access to CODESYS Store, library documentation, and overlay visualization**
- **No change to the user interface**

Benefit for CODESYS users:

Reduced risk of attacks when surfing, e.g. in the CODESYS Store

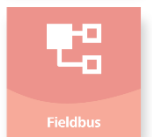
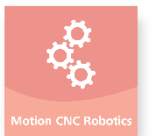
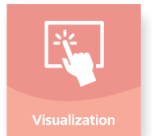

Package Manager

- Faster package installation
- Installation of interface components directly through a package
- New hooks for device manufacturers for rejecting a package

**Benefit for CODESYS users:
Faster package installation**

 Package Manager

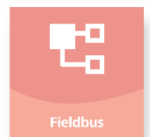
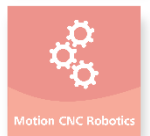
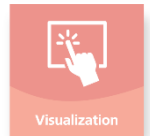

New library: [IIoT Libraries SL](#)

- **IIoT communication / reading and writing of data structures**
- **Included libraries with former workstation licensing:**
 - Web Client SL (Communication via http, https)
 - MQTT Client SL (Communication via MQTT)
 - Mail Service SL (Sending/receiving e-mails)
 - SMS Service SL (Sending/receiving SMS)
 - SNMP Service SL (Supervision of device states via SNMP agent and manager)
 - SNTP Service SL (SNTP server and client for time queries)
 - AWS IoT Core Client SL (Communication with AWS IoT Core based on MQTT)
 - Azure IoT Hub Client SL (Communication with MS Azure IoT Hub based on MQTT and https)
 - CSV Utility SL (Reading/writing of CSV files)
 - INI File Utility SL (Reading/writing of INI files)
 - JSON Utilities SL (Reading/writing of JSON files / strings)
 - XML Utility SL (Reading/writing of XML files / strings)
- **Sample projects included**

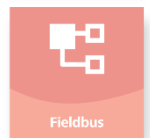
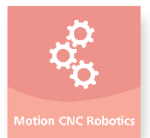
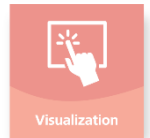

New library: [Control Loop Library](#)

- **Closed loop controllers / filters for process control / signal processing**
- **Included function blocks for closed loop controllers / add-ons:**
 - P-, PD-, PI-, PID-, two-point and three-point controllers
 - Function blocks for integral estimation
 - Function blocks for derivation estimation
 - Function blocks for anti-windup strategies
(Different strategies: Prevent integrator overflow in case of a longer lasting control deviation)
 - Filter
(Finite impulse response filters, infinite impulse response filters, second order section filters)
 - PWM generator
 - Abstract basic function blocks for the creation of individual components
- **Sample projects included**
- **Download and usage for free – no licensing necessary**

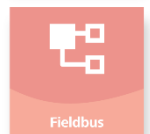
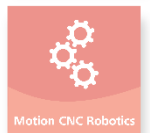

New library: Net Base Services 2

- **Function blocks for the communication via TCP/IP and UDP**
- **Included in the setup of the CODESYS Development System**
- **TLS support for secure TCP/IP communication**
- **Pure IEC 61131-3 implementation
→ Portable to any CODESYS platform)**
- **Support of multitasking / multicore**
- **Usage of IEC Tasks for asynchronous calls**
- **Usage of optional libraries (e.g. CmpTls, CmpCrypto)
→ Support of many different runtime systems**
- **Usage in POUs with graphical programming languages and "synchronously" via corresponding methods (transmission/reception in one cycle)**
- **Sample projects in the CODESYS Store**

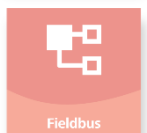
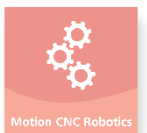
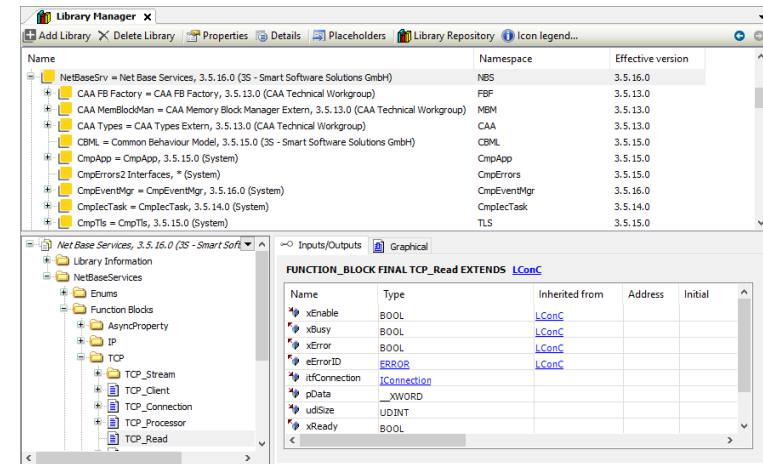

New language features: Optional Inputs of methods and functions

- Known from other programming languages
- CODESYS-specific extension of the IEC 61131-3
- Inputs with initial value: No need to pass variables in the call
- Consistently integrated in the user interface

```

1 iResult := Increment(iVal := iSomeValue, iBy := 2);
2 iResult := Increment(iVal := iSomeValue);
3
4 iResult := Increment(iSomeValue, 3);
5 iResult := Increment(iSomeValue);
6
7 iResult := Increment( // Show Tooltip and intellisense

```

```

FUNCTION Increment: INT
VAR_INPUT iVal INT
VAR_INPUT iBy INT := 1;

```

```

1 iResult := Increment(iVal := iSomeValue, iBy := 2);
2 iResult := Increment(iVal := iSomeValue);
3
4 iResult := Increment(iSomeValue, 3);
5 iResult := Increment(iSomeValue);
6
7 iResult := Increment(iB // Show Tooltip and intellisense

```

```
[iBy := 1]
```



Engineering



Runtime



Visualization



Motion CNC Robotics



Fieldbus



Safety

New language features: 64 bit data types for time date

- **64 bit data types**
 - LDATE
 - LDATE_AND_TIME
 - LTIME_OF_DAY
 - analog to the 32bit variants DATE, TIME_OF_DAY, DATE_AND_TIME
- **Realization compliant to the IEC 61131-3**

Expression	Type	Value
IdDate	LDATE	LD#2125-6-11
IdtPreciseTrigger	LDATE_AND_TIME	LDT#2020-7-12-16:15:10.500000000
ItodPreciseTimeStamp	LTIME_OF_DAY	LTOD#11:38:27.123123123



Engineering



Runtime



Visualization



Motion CNC Robotics



Fieldbus



Safety

Smart Coding and Usability: New Autodeclare options in SmartTags

- Common operations already offered as SmartTag (“light bulb”), e.g. declaration of (local) variables
- Input in dialog no longer required for execution
- Input in auto declare dialog not necessarily required for execution

```
1 someVar := 'Test';  
2
```

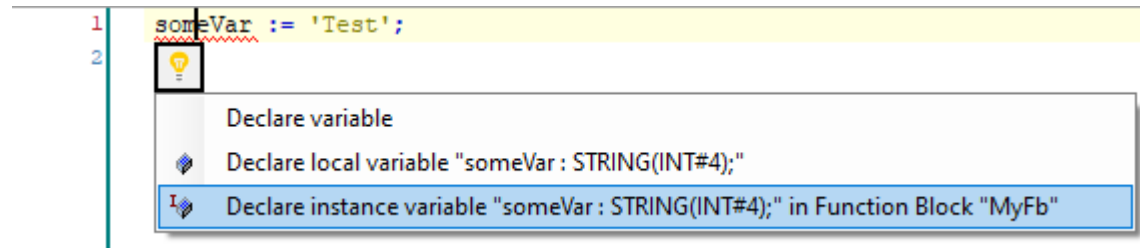

The screenshot shows a code editor with two lines of code. Line 1 is highlighted in yellow and contains the text `someVar := 'Test';`. A light bulb icon (SmartTag) is positioned over the variable `someVar`. A context menu is open below the icon, listing three options: "Declare variable", "Declare local variable "someVar : STRING(INT#4);", and "Declare instance variable "someVar : STRING(INT#4);" in Function Block "MyFb". The third option is selected and highlighted in blue.

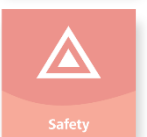
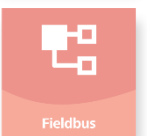
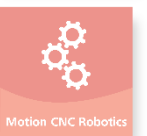
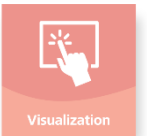
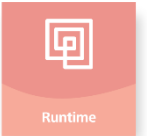
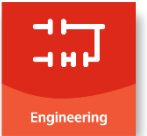

Smart Coding and Usability: Improved Cross Reference View

- **New column: Usage context**
 - Can be filtered
 - Find very precisely relevant places of use

Cross Reference List

__POOL.assign_lint_bit.error4 Filter by Symbol, POU, Variable, Access, Cont

Symbol	POU	Variable	Access	Context	Type
error4	assign_lint_bit	error4	Dedaration	...ror3, error4 :BOOL:=TRUE;	BOOL
error4	assign_lint_bit	error4	Write	error4 := FALSE;	BOOL
error4	assign_lint_bit	error4	Read	...r2 OR error3 OR error4);	BOOL

Cross Reference List

Device.Application.CrossRef_Demo.myvar ADR|

Symbol	POU	Variable	Access	Context	Type	Address	Location	Object	Comment
myvar	CrossRef_Demo	myvar	Dedaration	myvar : INT;	INT		Line 3 (Ded)	CrossRef_Demo [Device: PLC Logic: Application]	
myvar	CrossRef_Demo	myvar	Write Address	somePtr := ADR(myvar);	INT		Line 20, Column 16 (Impl)	CrossRef_Demo [Device: PLC Logic: Application]	
myvar	CrossRef_Demo	myvar	Write Address	somePtr := ADR(myvar);	INT		Line 58, Column 16 (Impl)	CrossRef_Demo [Device: PLC Logic: Application]	
myvar	CrossRef_Demo	myvar	Write Address	somePtr := ADR(myvar);	INT		Line 96, Column 16 (Impl)	CrossRef_Demo [Device: PLC Logic: Application]	
myvar	CrossRef_Demo	myvar	Write Address	somePtr := ADR(myvar);	INT		Line 134, Column 16 (Impl)	CrossRef_Demo [Device: PLC Logic: Application]	
myvar	CrossRef_Demo	myvar	Write Address	somePtr := ADR(myvar);	INT		Line 172, Column 16 (Impl)	CrossRef_Demo [Device: PLC Logic: Application]	
myvar	CrossRef_Demo	myvar	Write Address	somePtr := ADR(myvar);	INT		Line 211, Column 16 (Impl)	CrossRef_Demo [Device: PLC Logic: Application]	

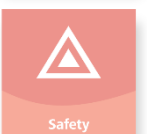
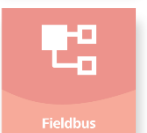
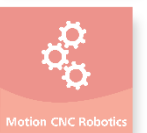
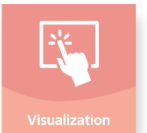
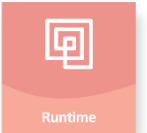
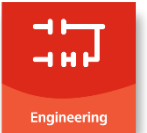

Smart Coding and Usability: Improved Library Manager

- **Better navigation in the Library Manager Editor with linked identifiers**

- Find referenced libraries or data types
- Browse the referenced links forward and backward



- **Specific deactivation of repositories possible**

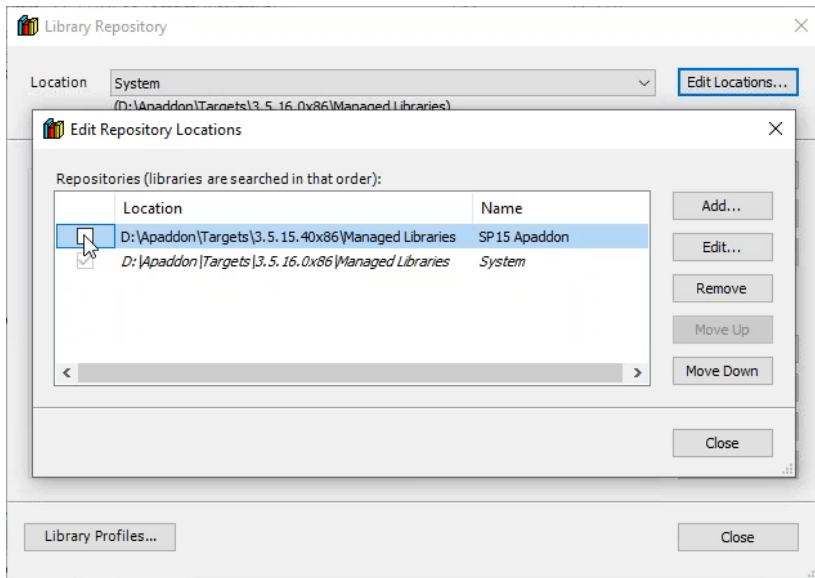

Inputs/Outputs | Graphical | Documentation

FUNCTION_BLOCK GetBusError EXTENDS [CBM.ETriqA](#)

Name	Type	Inherited from
xExecute	BOOL	CBM.ETriqA
xAbort	BOOL	CBM.ETriqA
xDone	BOOL	CBM.ETriqA
xBusy	BOOL	CBM.ETriqA
xError	BOOL	CBM.ETriqA
xAborted	BOOL	CBM.ETriqA
itfNode	INode	
eError	ERROR	
einBusError	ERROR_INFO	

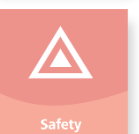
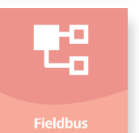
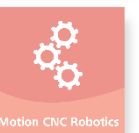
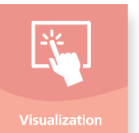
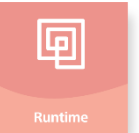

Smart Coding and Usability: Improved Library Manager

- Recursive reloading of libraries
- No more popup window for missing libraries
- Quickfix for missing libraries

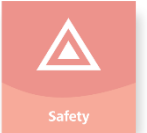
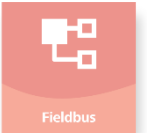
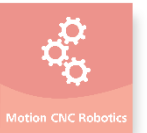
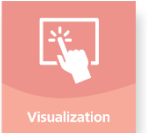
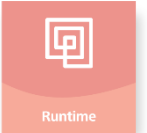
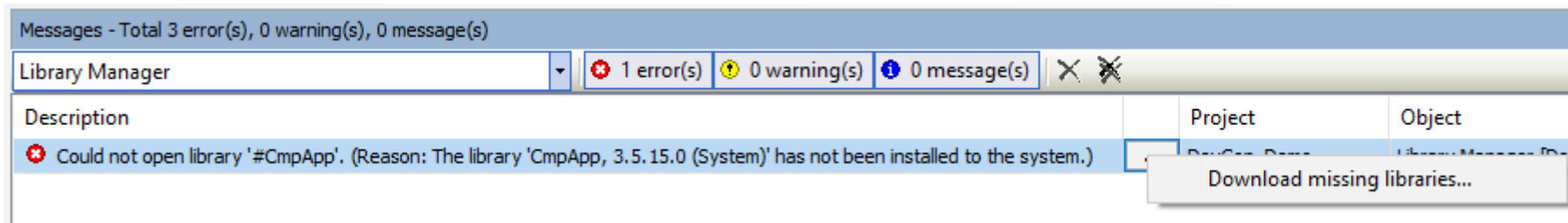
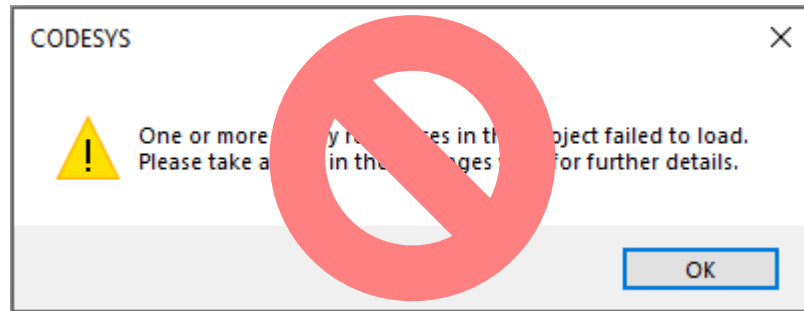

Memory consumption in CODESYS

- **Reduction of memory consumption for the compiler:**
 - In total about 50% less RAM needed
 - 25% less RAM for the CODESYS Development System
 - May save up to hundreds of megabytes of RAM
- **Further improvements of compile / generate code: Pending (SP17)**

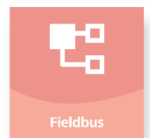
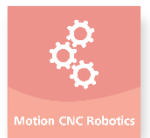
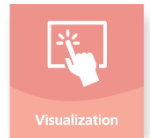
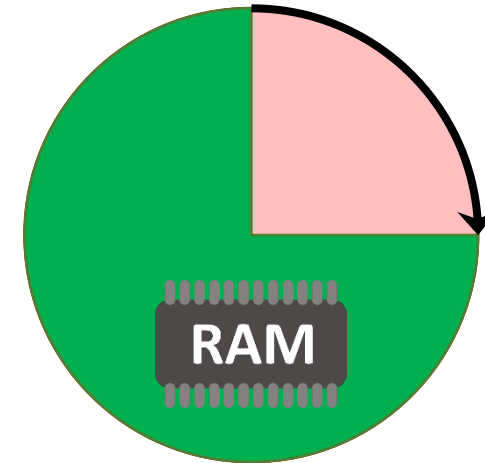

CODESYS Static Analysis: New configuration

- Faster configuration with better overview due to categories, filters, and sorting

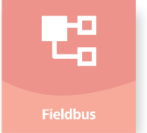
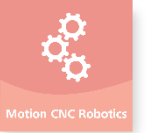
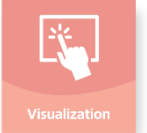
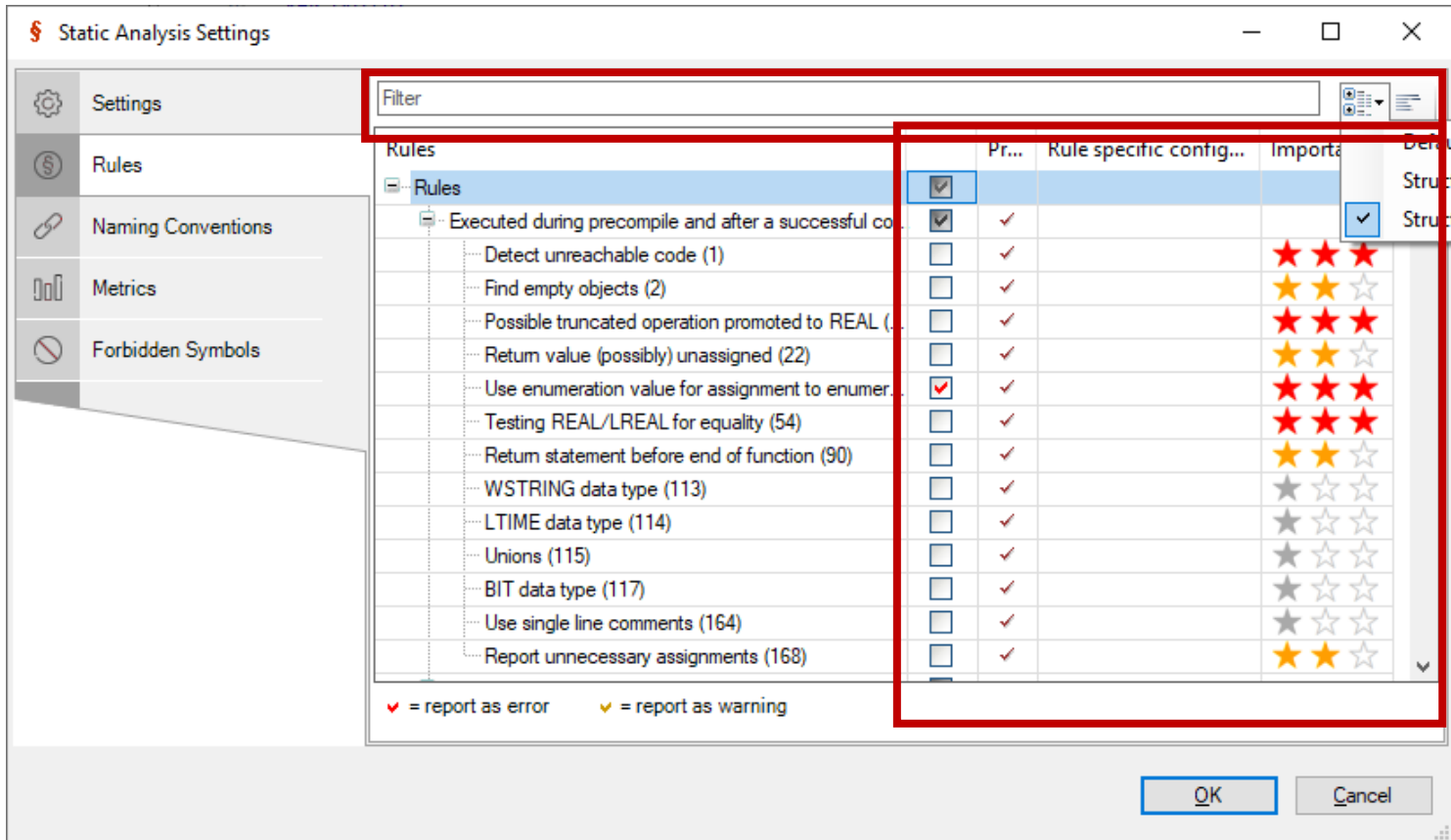

CODESYS Static Analysis: Automatic execution

- Execution of Static Analysis during coding
- Quickfix of results
 - By SmartTag (“light bulb”)
 - In the message window

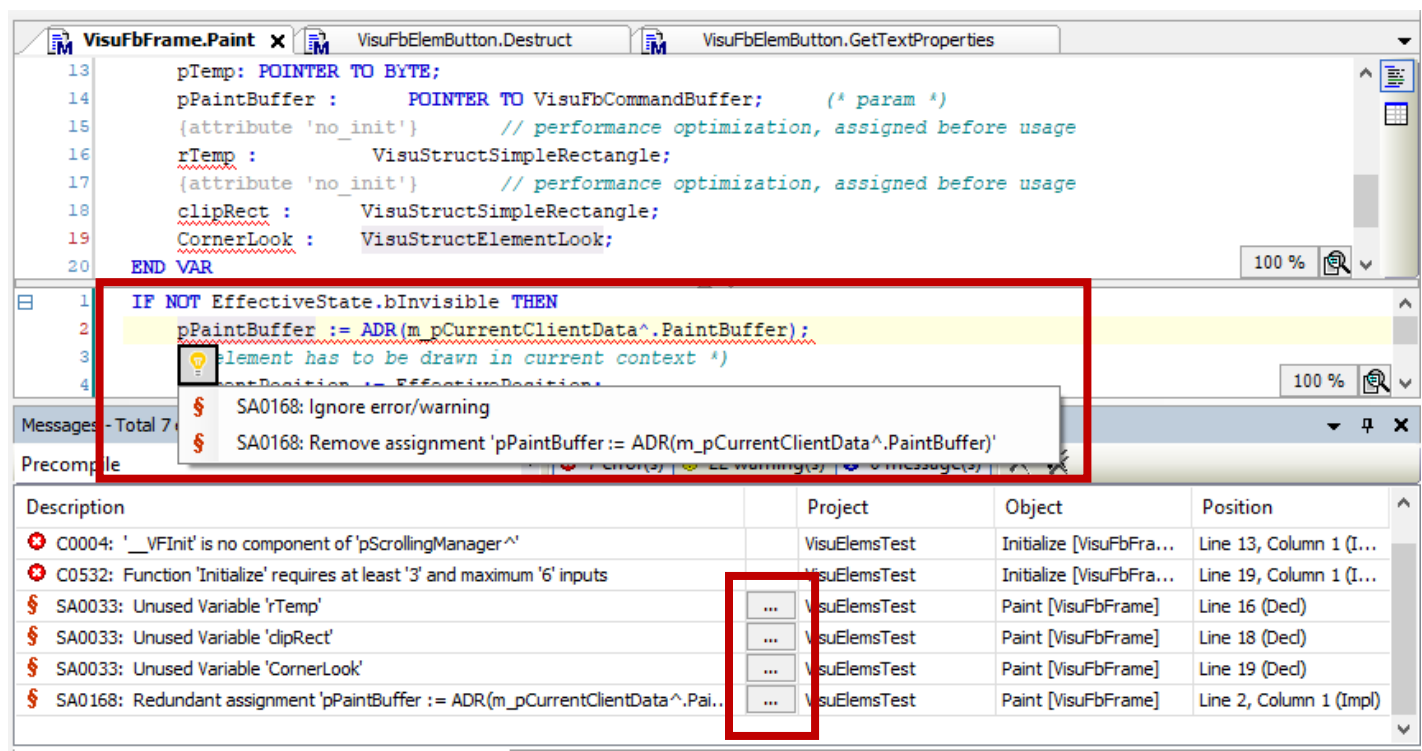
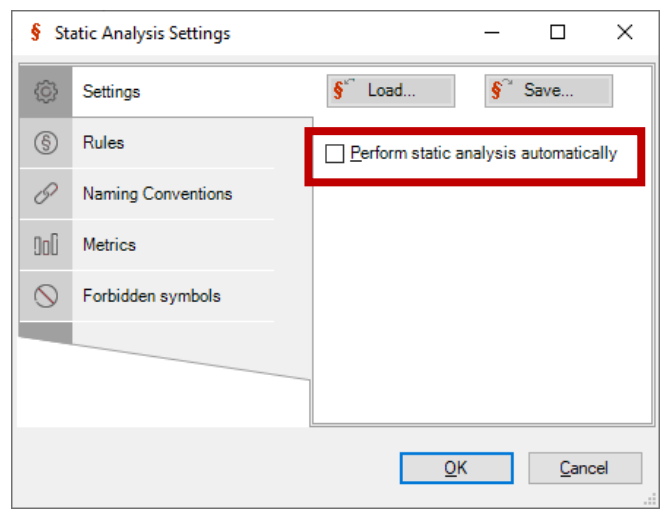
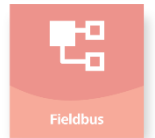
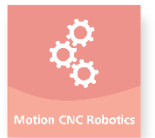
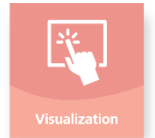

CODESYS Static Analysis: Clone Detection (from version 4.4.0.0)

- Check entire project for structurally identical code (ST code only)
- List view
- Comparison in separate window
- Complexity filter
- Object name filter
- Summary with clone ratio

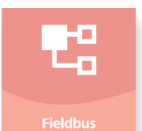
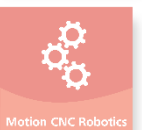

The screenshot displays the 'Clone detection results' window for a project named 'PLC_PRG'. It features two side-by-side code editors showing identical code blocks highlighted in yellow. The left editor shows an 'IF b1 THEN' block with lines 2-10 containing 'x1 := x1 + 1;' through 'x1 := x1 + 8;', followed by 'neu := 10;'. The right editor shows an 'ELSE' block with lines 12-19 containing 'y1 := y1 + 1;' through 'y1 := y1 + 8;', followed by 'wasanderes := neu;'. Below the editors, a summary bar indicates 'Subnodes/Clone: 48' and '48' with a note: 'Identical background colors means identical code'. A table below the summary lists the detected clones:

Description	Subnodes/Clone	Object	Position
PLC_PRG	48		
9 lines of cloned code		PLC_PRG [Application]	Line 2, Column 2 (Impl)
9 lines of cloned code		PLC_PRG [Application]	Line 12, Column 2 (Impl)

CODESYS Static Analysis: Extract Methods

- Automatic parameter detection
- Preview in the editor
- Preview of new method

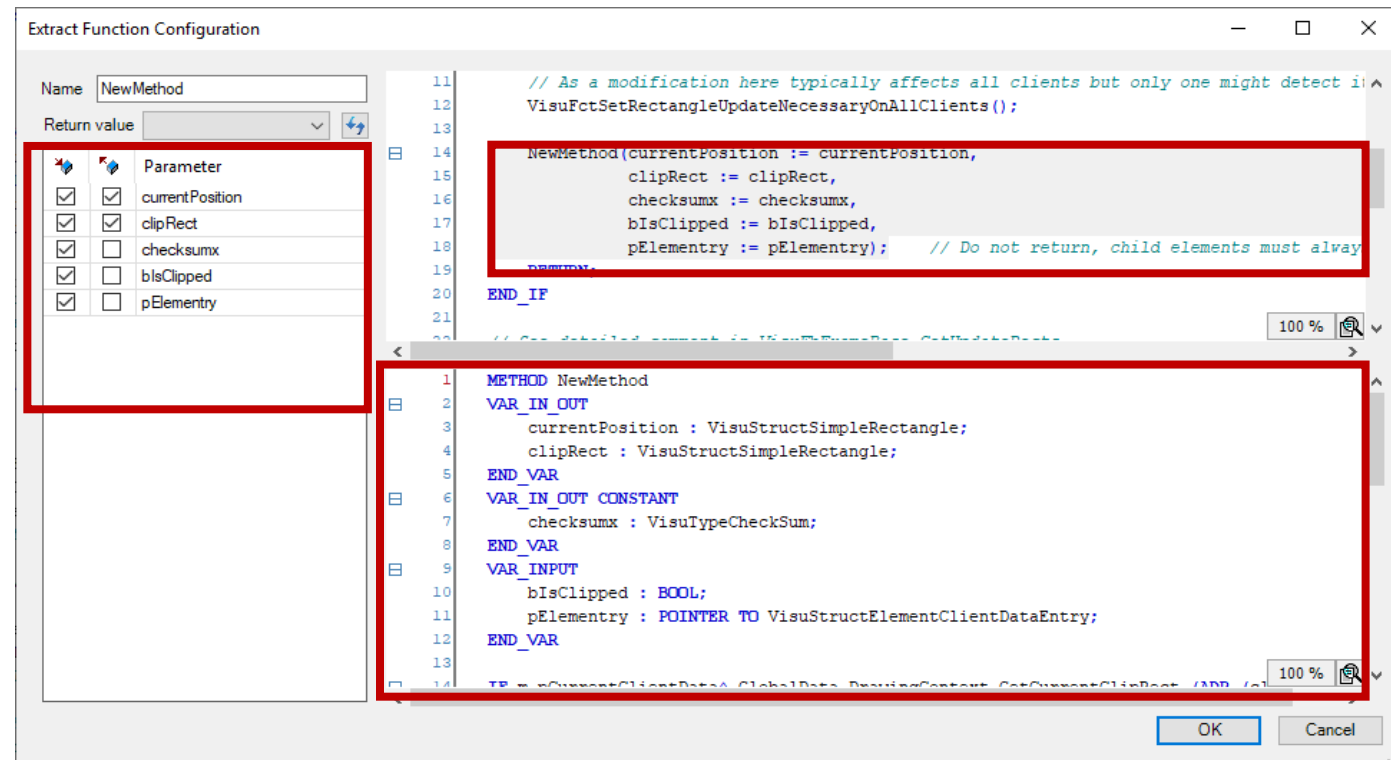

- Watch new video under <https://youtu.be/Q7If5ceYBc8>

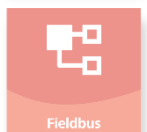
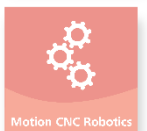

CODESYS Profiler

- **New measuring method: Sampling**

- Minor influence on the cycle times of the application
- Prevents Profiler to trigger watchdogs
- Process flow (almost) not disturbed
- Measurements much more meaningful / less falsified
- Prerequisite: Controller supports multicore
 → Profiler task on different core than monitored task

- **Profiler Watch List**

- Real time information on cycle times of POU's

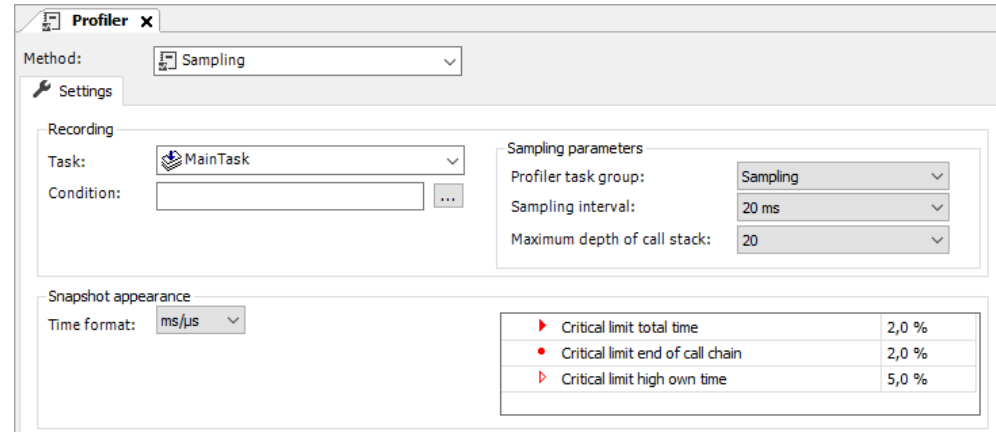
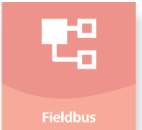
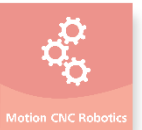

Profiler Watch List								
POU	Instance	Application	Count	Duration	Min. Duration	Max. Duration	Sum Duration	Avg. Duration
Timer	PLC_PRG.Orderdata._timer	Device.Application	638	LTIME#15us800ns	LTIME#13us700ns	LTIME#46us	LTIME#11ms477us600ns	LTIME#17us989ns
PLC_PRG		Device.Application	1091	LTIME#136us300ns	LTIME#54us500ns	LTIME#328us200ns	LTIME#137ms186us900ns	LTIME#125us744ns
ChangeLog		Device.Application	936	LTIME#29us100ns	LTIME#13us800ns	LTIME#62us	LTIME#17ms659us300ns	LTIME#18us866ns

- **New video in the CODESYS Channel on YouTube shortly!**

CODESYS SVN

- Conversion to core separation
- Performance improvement:
Compare of working project with base project speeded up

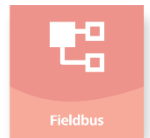
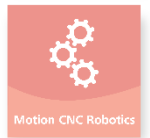
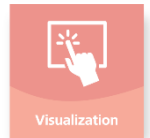
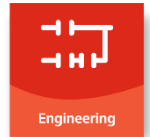

CODESYS Test Manager: Improvements for users

▪ TestDriverDevices:

- Set communication with IP/DNS:
Scan for devices:
In addition to Hostname / CODESYS address **now** for IP address or DNS name
No filtering for Target ID and Target Type or Name
- Set communication, filtering by Target ID and target type:
only with host name

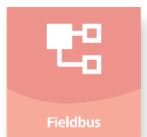
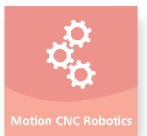

Test Action Extended Settings

Title: Set communication Action: SetCommunicationPath (TestManager.Devices)

Configuration Credentials (inactive) Parameters (0/0)

Device name: Device

Gateway name: Gateway-1

Target address:

Target name: BECKSTNB

Local PLC: Specify instance of PLC:

Target IP/DNS:

Restrict to device type: 4098

Restrict to device ID:

Encrypted communication certificate: Connect to device immediately and trust certificate

CODESYS Test Manager: Improvements for users

- **TestDriverTestReport:**

- Report installed CODESYS packages, report Windows platform (32/64 bit)

- **TestManagerEditor:**

- Generate command line template for executing a particular script

Copy command line to clipboard

Create Test Script

```
C:\WINDOWS\system32\cmd.exe
Microsoft Windows [Version 10.0.18363.720]
(c) 2019 Microsoft Corporation. Alle Rechte vorbehalten.

C:\Users\s.beck>"D:\SVN\AP\trunk\AddOns\TestManager\Targets\3.5.16.0x86\Common\CODESYS.exe" --profile="CODESYS V3.5 SP16"
--exitafterexecutecommand --executecommand="TestManager ExecuteScript" --arg1:"--repository-location=C:\ProgramData\CODESYS
Test Manager\Test Repository" --arg2:"--script=TM-481" --arg3:"--version=0.0" --arg4:"--tester=s.beck" --arg5:"--save-xml=C:\Users\s.beck\Documents\TestManagerReports\TM-481(0.0).xml" --arg6:"--save-html=C:\Users\s.beck\Documents\TestManagerR
eports\TM-481(0.0).html" --arg7:"--progress=stdout;window"
```

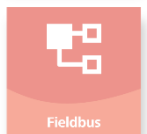
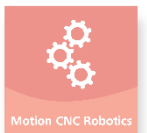

CODESYS Test Manager: Improvements for CODESYS Automation Platform users

- **TestDrvFileTransfer:**
 - Recursive directory transfer
- **TestDrvVisu:**
 - Scripts without COMPARE statement
Requires change in runtime system
(CmpTargetVisuAutoTest) for SP16

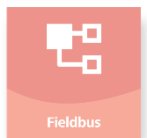
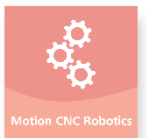
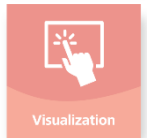

The screenshot shows the 'Test Action' configuration window with the following details:

- Title:** TV-Test
- Action:** VisuScript (CoDeSys.Visualization)
- Configuration:** Reference Image, Parameters (0/0)
- Settings:**
 - Visualization type: Target visualization
 - Reference Image Folder: d:\tmp
- Visu script:**

```
1 WAITFACTOR 2
2 WAIT 200
3 MOUSEDOWN POINT(100, 150)
4 WAIT 200
5 MOUSEMOVE POINT(100, 150)
6 WAIT 200
7 MOUSEUP POINT(100, 150)
8 COMPARE
9
```

A red box highlights the 'COMPARE' statement on line 8, with a red arrow pointing to the text: **Can now be left out.**

CODESYS UML

- Refactoring UML Class Diagram
 - Changes in the UML Class Diagram (e.g. renaming): Execution of the CODESYS refactoring functionality
 - Display of the refactoring preview: Can be switched off

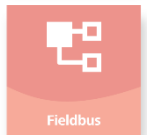
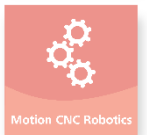
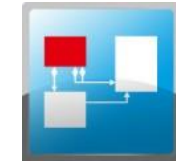
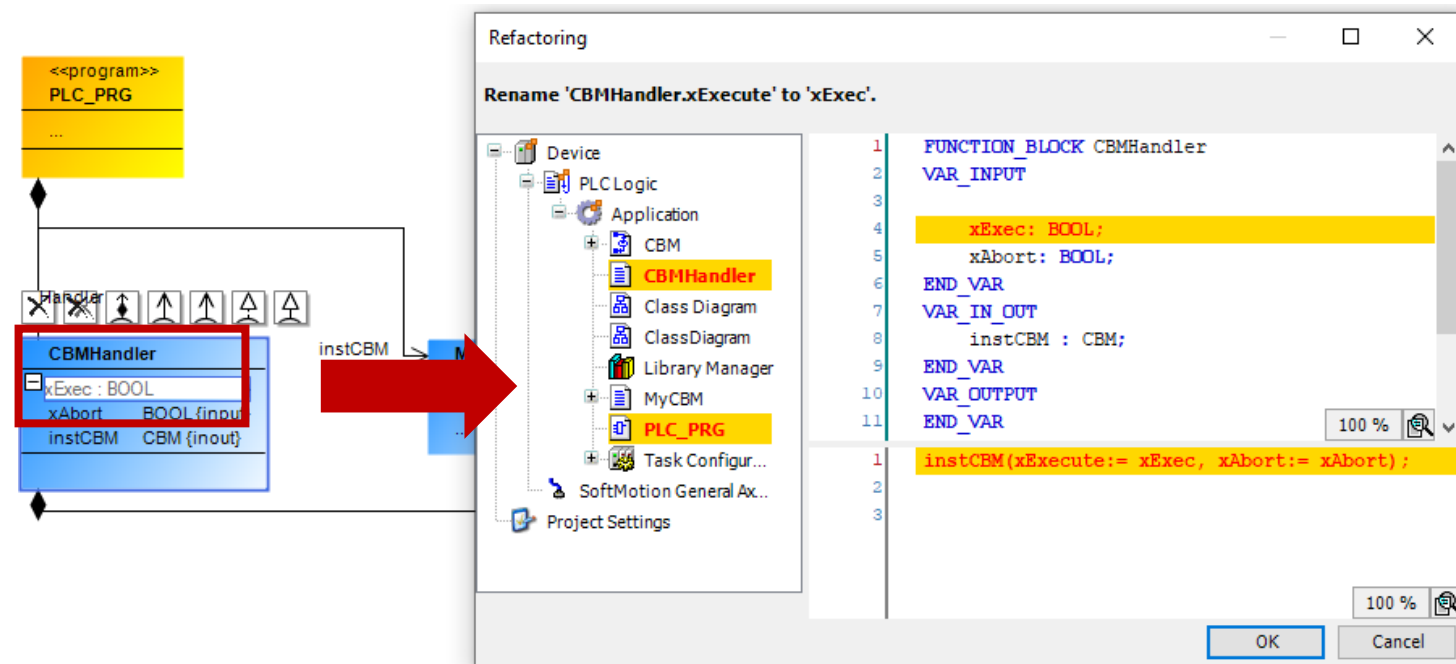

1

Engineering

2

Runtime

3

Visualization

4

Motion CNC Robotics

5

Fieldbus

6

Safety

Overview

- **OPC UA Client**
- **Secure client access to runtime systems**
- **Optional libraries for optional components**
- **Runtime system documentation**
- **CODESYS Control for Linux ARM SL (Demo)**
- **CODESYS Control for WAGO Touch Panels 600 SL**
- **CODESYS Safety SIL2 PSP**
- **CODESYS Control RTE: Support of real-time IP communication**
- **CODESYS Control VxWorks: Support of LLVM Compiler**
- **Further improvements**

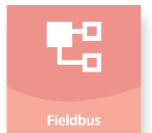
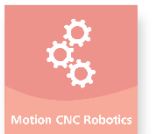
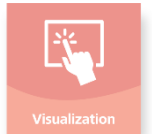
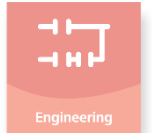

OPC UA Client: Architecture overview

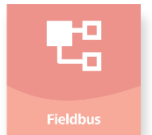
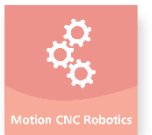
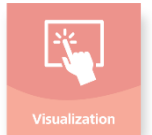
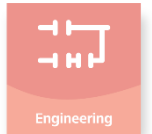
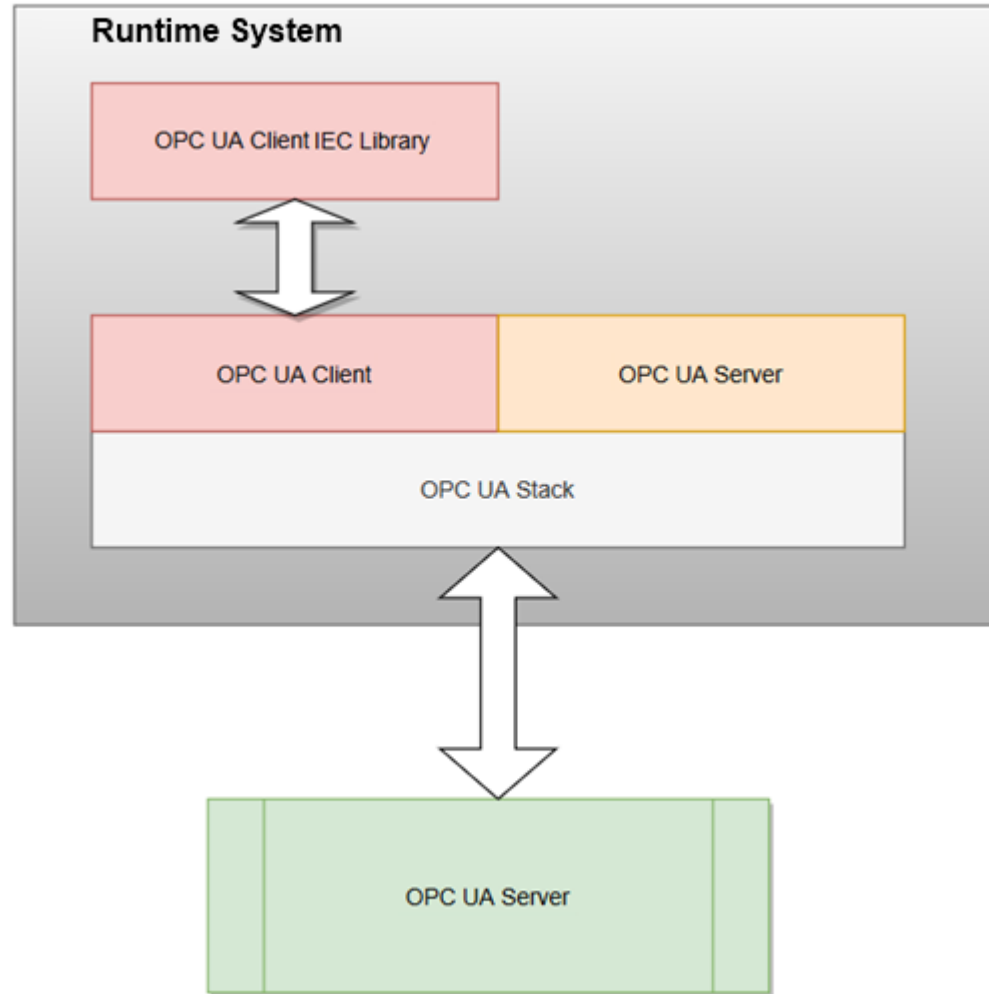

OPC UA Client: Supported features

- **Create / Delete Instance**
- **Discovery** (GetEndpoints, FindServers)
- **Session Management** (CreateSession, CloseSession, ActivateSession)
- **Browsing** (Browse, BrowseNext, Translate, RegisterNodes, UnregisterNodes)
- **Attributes** (AttributeRead, AttributeWrite)
- **Subscriptions** (CreateSubscription, DeleteSubscription, ModifySubscription, SetPublishingMode)
- **MonitoredItems** (CreateMonitoredItem, DeleteMonitoredItem, ModifyMonitoredItem, SetMonitoringMode)

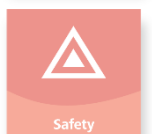
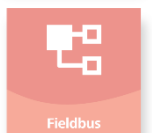
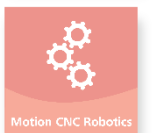
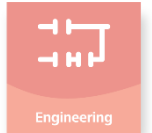

Secure client access to runtime systems

- **Identification of connected client types and users on the controller**
 - More flexibility for future authentication methods
- **Secure authentication of users:**
 - Stronger obfuscation during password transfer
 - Stronger hash while saving the passwords on the controller
 - Improved infrastructure:
 - Easier integration of future authentication methods
 - Better separation of user administration and user configuration (for device manufacturer or OS connection)

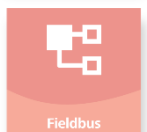
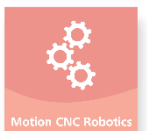
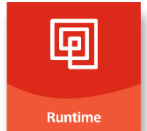
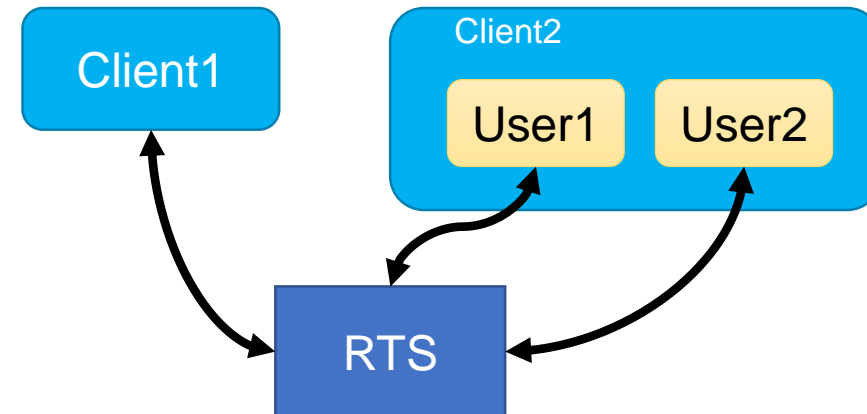

Secure client access to runtime systems: Client types

- **CODESYS Development System**
- **CODESYS Development System via CODESYS Automation Server**

- ***PLCHandler***
- ***Edge Gateway***
- ***Data Sources***
- ***WebVisu***
- ***Remote Target Visu***
- ***OPC UA Client***

```

sessinfo-list
-----
Channel number:      n/a
Client type:         SESS_INFO_CLIENT_TYPE_OPC_UA_CLIENT
User name:
ApplicationName:    Unified Automation UaExpert
ProductUri:         urn:UnifiedAutomation:UaExpert
ApplicationUri:     urn:HORNUNGANB:UnifiedAutomation:UaExpert
Client version:
Client CDS version
-----
Channel number:      0
Client type:         SESS_INFO_CLIENT_TYPE_PROGRAMMING_SYSTEM
User name:
Client name:         CODESYS
Client vendor name: CODESYS Development GmbH
Client host name:   HORNUNGANB.in.3s-software.com
Client version:     CODESYS V3.5 SP16
Client CDS version  3.5.16.0
-----
    
```

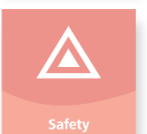
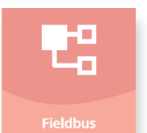
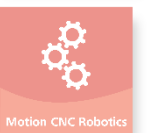
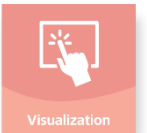
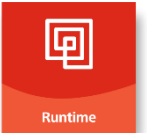
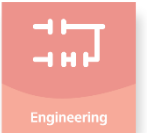

Query session information from IEC code, runtime system and PlcShell command

Secure client access to runtime systems: Improved infrastructure for user management in the runtime system

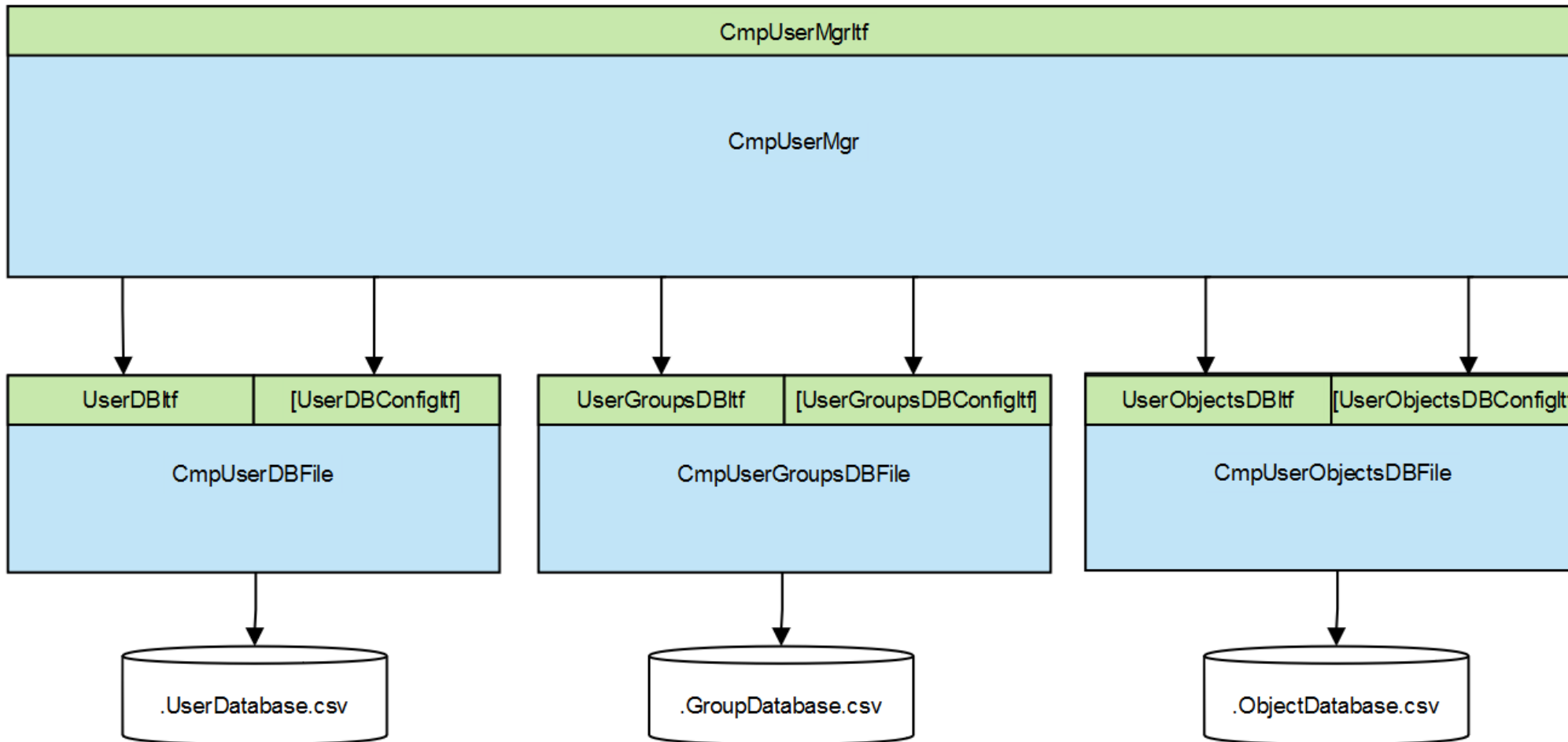

Engineering



Runtime



Visualization



Motion CNC Robotics



Fieldbus



Safety

Secure client access to runtime systems: Future usage (outlook)

- **Simultaneous login of CODESYS / CODESYS Automation Server into an IEC application:**
 - Deny access
 - Report client / optional user and coordinate access
- **Recording of user actions:**
 - To a separate log file
 - Audit Trail (audit-proof storage)

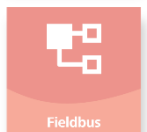
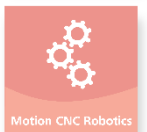
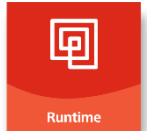

Optional libraries for optional components

- **Optional runtime system components:**
 - Resource consumption or OS requirements
→ Components cannot be installed in every runtime system
- **Typical examples of optional runtime system components:**
 - CmpOpenSSL
 - CmpOPCUAClient + CmpOPCUAServer
 - CmpEventMgr
 - SysSocket
 - SysSem
 - SysShm
 - CmpRedundancy
 - ...
- **Optional external libraries:**
 - Component with IEC interface

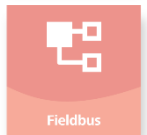
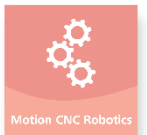

Optional libraries for optional components

- **Divided into three libraries:**
 - Container library (fixed version)
 - Interface library (* newest)
 - Implementation library (is resolved by placeholders from the DevDesc)

[-] SysSocket = SysSocket, 3.5.15.0 (System)	SysSocket	3.5.15.0
+ [-] SysSocket Implementation = SysSocket Implementation, 3.5.15.0 (System)	SysSocket_Implementation	3.5.15.0
+ [-] SysSocket Interfaces, * (System)	SysSocket_Interfaces	3.5.15.0

- **Library placeholder in the Device Description:**
 - Created by the DeliveryManager: If the corresponding component is installed in the runtime system
 - No more misconfiguration!
 - Conditional compilation in user code against optional library!

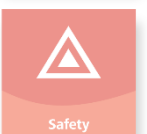
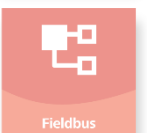
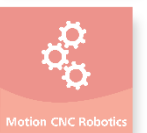
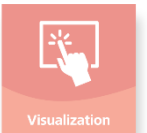
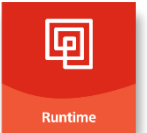
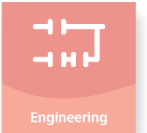

Runtime system documentation for device manufacturers

- **Runtime system online help significantly improved**
 - New: table of contents with interactive unfolding/folding of chapters and tile-based entry page
 - Consistent full-text search: Documentation in HTML wherever possible
 - New main chapters: "Runtime Variants" and "Runtime Adaptation"
 - Significant improvement of the reference documentation:
 - New chapters for compiler switches, defines, settings, events, tasks, logger entries, etc.
 - Significantly improved documentation of features (generated links to components, target settings, necessary features, etc.)
 - Workshop presentation: Now also part of the online help
- **For device manufacturers:
Available in the customer portal
(most recent released version)**

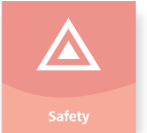
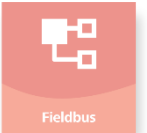
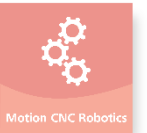
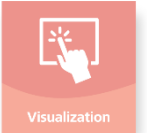
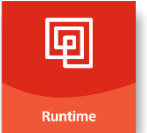
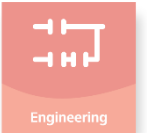
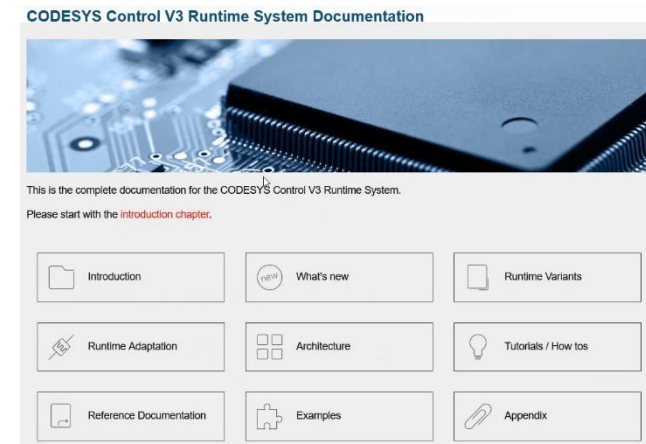

CODESYS Control for Linux ARM SL (Demo)

- **Integrated Features**
 - MultiCore
 - CODESYS WebVisu
 - Security Manager
 - OPC UA Server
 - SocketCAN
 - Common Fieldbus Systems, e.g. EtherCAT, EtherNet/IP, PROFINET
- **Generic SoftPLC for ARM devices with Linux (Debian and derivatives)**

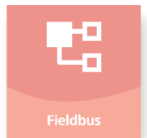
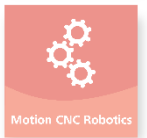
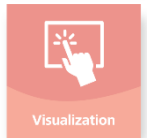

CODESYS Control for WAGO Touch Panels 600 SL

- **HW-Support: WAGO Touch Panel Serie**

- Webpanel: 10.1" / 7" / 5.7" / 4.3"
- Ethernet / USB / CAN / Serial / (DIO)
- RT-Preempt Linux
- 2 Core ARM Cortex A9
- 2GB RAM / 60MB Flash + SD

- **CODESYS Features**

- Single License per device (per CodeMeter Runtime: Dongle / SoftContainer)
- CODESYS MultiCore
- CODESYS WebVisu
- Security Manager
- CODESYS OPC UA Server
- SocketCAN
- Common Fieldbus Systems, e.g. EtherCAT, EtherNet/IP, PROFINET
- Optional: Support for Motion CNC Robotics

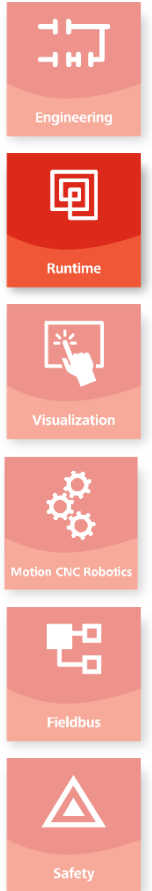

CODESYS Safety SIL2 PSP

- **PSP: Platform Support Package for manufacturers of safety controllers**
- **Pre-certified SIL2 runtime system toolkit for a specific platform**
 - Already released: TI RM48 and TMS570
 - **New: Infineon AURIX TC29X**
- **Contains**
 - System adaptation to the platform
 - Error analysis of the modules used
 - Pre-certified parts with already fulfilled requirements from CODESYS Safety SIL2
 - Simplified interface (RTSSIL2PSP.Itf)
 - Tool validations of the tools used
 - Integration tests
- **Reduced development and certification efforts for device manufacturers**
 - Dimension for savings: ≥ 4 man-years

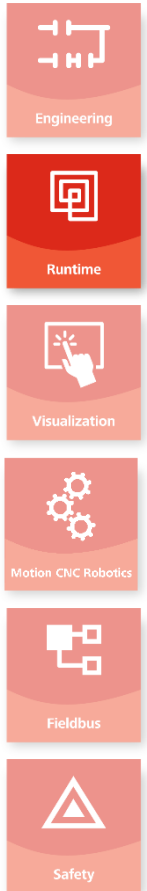

CODESYS Safety SIL2 PSP: Architecture / Implementation for device manufacturers

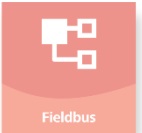
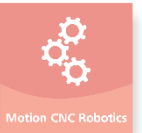
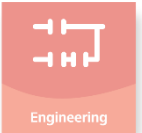
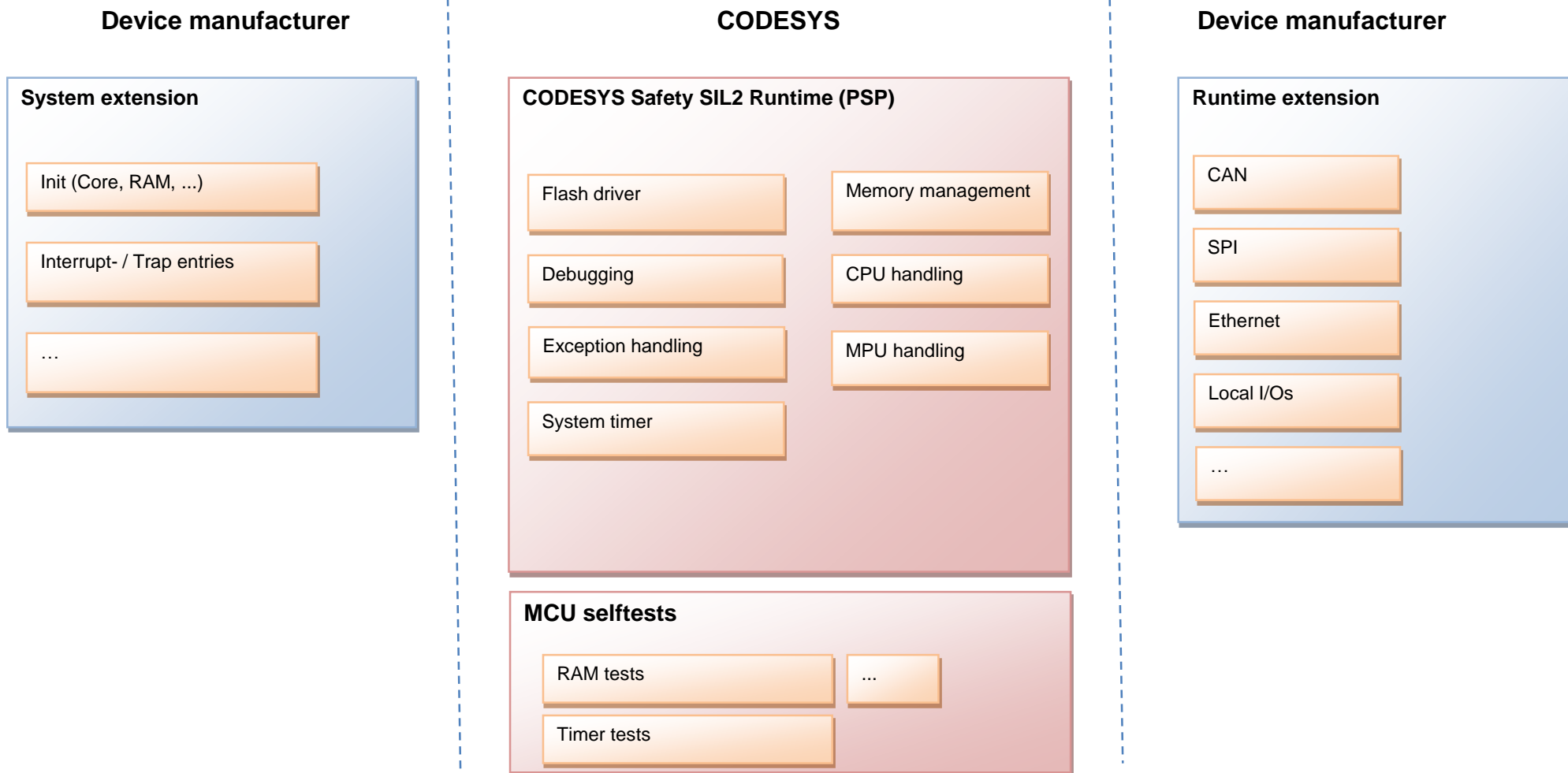

CODESYS Control RTE: Support of real-time IP communication

Basic principle

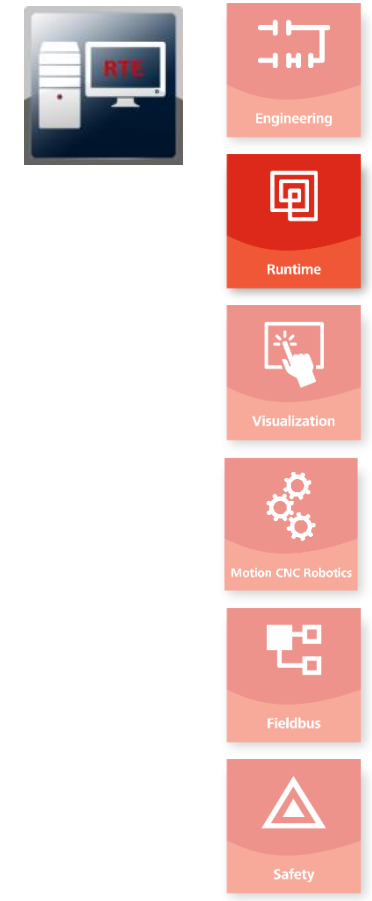
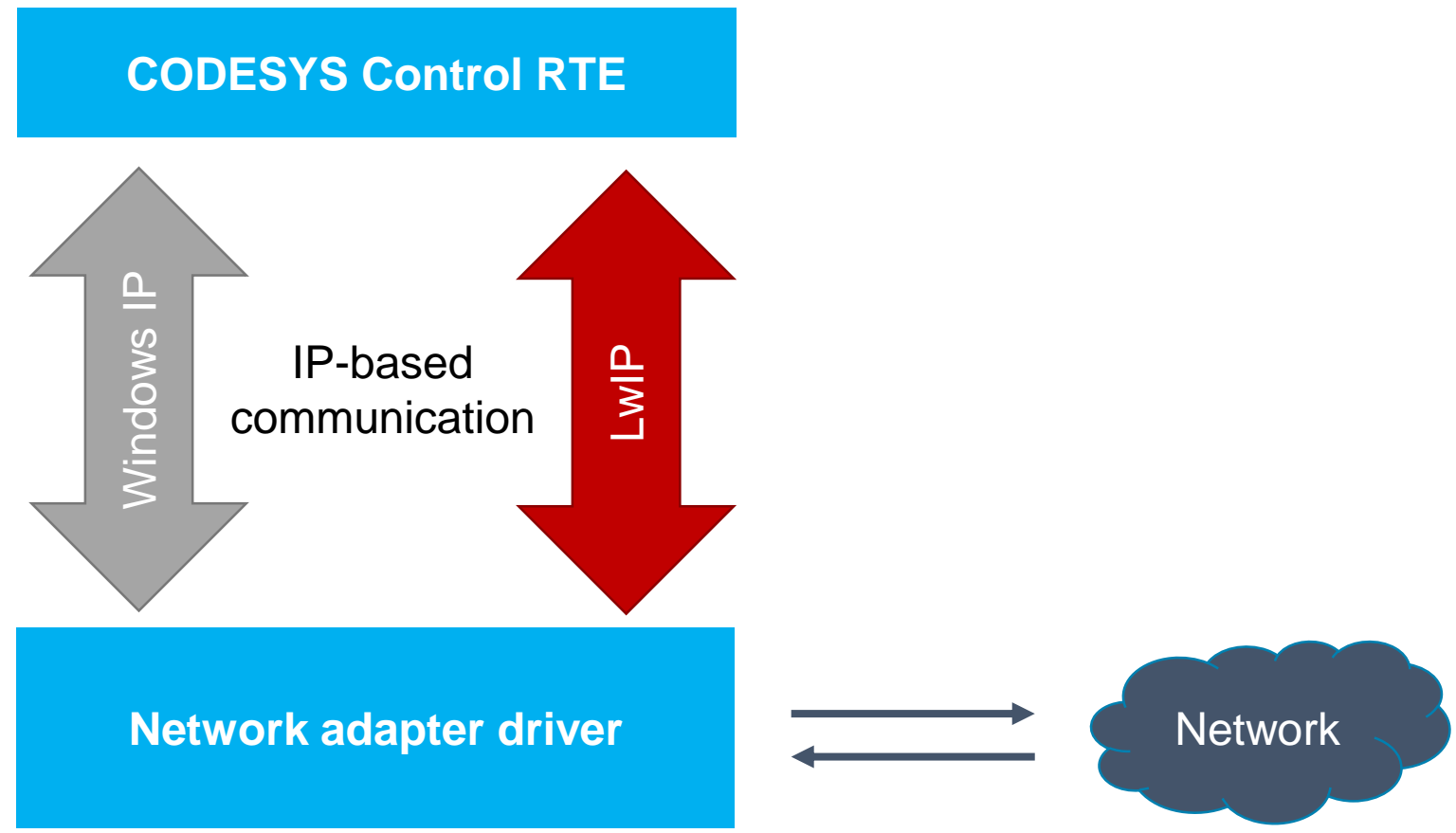

CODESYS Control RTE: Support of real-time IP communication

- **LwIP: Lightweight IP:**
 - Widely used open source TCP/IP stack developed for embedded systems
- **Main focus: Reduction of resource consumption with the simultaneous presence of a fully functional TCP stack**
- **Real-time capability: Based on use of CODESYS network adapter drivers (Intel and Realtek) to access the network directly**
- **Benefits**
 - Real-time capable IP-based communication (without using the Windows IP driver)
 - e.g. for network variables, EtherNet/IP, Modbus
 - Even possible: Usage simultaneously to fieldbus systems e.g. EtherCAT or PROFINET

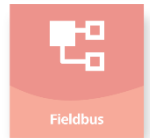
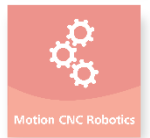
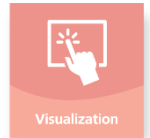

CODESYS Control RTE: Support of real-time IP communication

Performance measurements

	V3.5 SP15	V3. SP16 (without LwIP)	V3.5 SP16 (with LwIP)
Download, 3.1 MB	6s	6s	1s
File Transfer, 10 MB	15s	15s	3s
OPC UA, Browse 1000 vars	35s	4s*	1s

*General revision of the memory management of CODESYS Control RTE (heap management) for V3.5 SP16

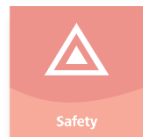
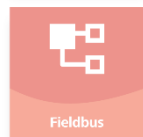
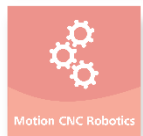
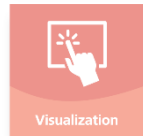
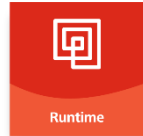
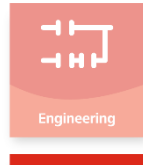

CODESYS Control VxWorks: Support of LLVM Compiler



- **LLVM: Low Level Virtual Machine**
- **Compiler backend**
 - Collection of compiler and toolchain technologies (C, C++, Objective-C and OpenCL) with a comprehensive translation concept
- **Compiler frontend: Clang**
- **Benefits of LLVM/Clang**
 - Required for the use of VxWorks 7
 - Uniform parser for C-based languages
 - Compatible with GCC compiler
 - High performance: Faster translation of the sources with less memory consumption
 - Often smaller executable programs



Further improvements

- **CmpSettings: Separation of read-only and writable cfg-file**
- **CmpBlkDrvUdp: Blacklist / Whitelist for Ethernet adapter**
- **CmpCrypto: Support for asymmetric crypto operations**
- **OPC UA Client: Debugging of callback functions in IEC code (infrastructure)**
- **OPC UA Server:**
 - OPC UA: Support multitasking / multicore
 - OPC UA Server: Access to comments of variables now possible
- **OPCServer/PLCHandler - Interfaces Gateway and ARTI: Support of V2 PLC password**

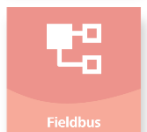
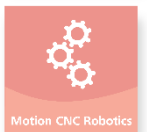
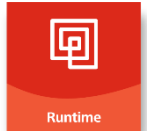

1

Engineering

2

Runtime

3

Visualization

4

Motion CNC Robotics

5

Fieldbus

6

Safety

Overview

- **WebVisu overlay**
- **Distributed alarm management for CODESYS HMI**
- **Alarm table**
- **Remote TargetVisu**
- **Keyboard operation**

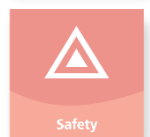
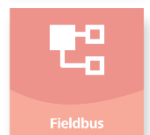
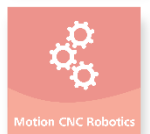
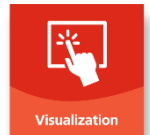
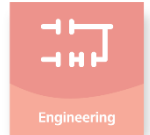

WebVisu overlay

- **Now released**
- **New drawing logic**
- **Elements as separated objects in the client**
- **Each element draws independently**
- **Arbitrary overlaps with native controls possible**

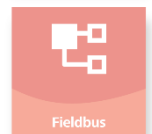
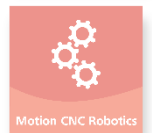
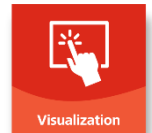
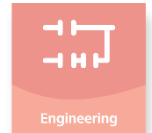
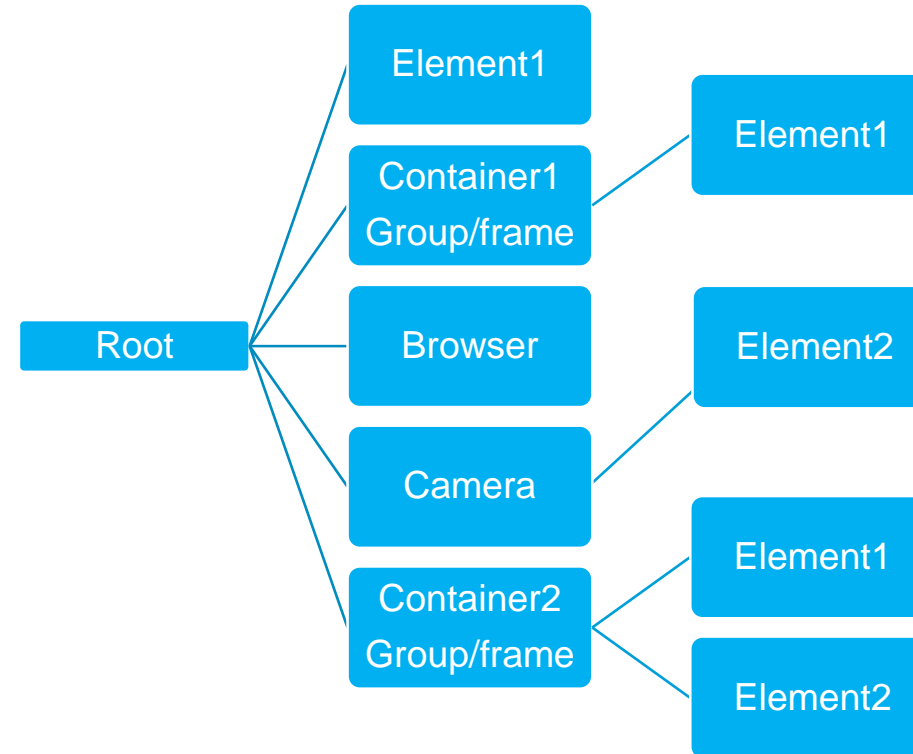

WebVisu overlay: New features

- **Dynamic movement for all elements**
 - Inner rotation for all elements (also for group, frame, or native control)
- **Time-controlled animations independent of VISU-TASK cycle**
 - Smooth moving of menus
 - Smooth transitions when showing/hiding dialogs
 - Update of animated images such as GIFs/SVGs
 - No load on the controller / PLC

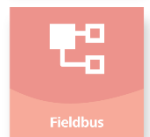
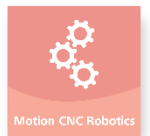
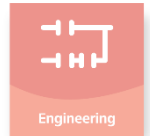

Distributed alarm management for CODESYS HMI

- Individual alarm management for each controller
- HMI: Monitoring of remote alarms via data source connection
- Central display of active and historical alarms from different controllers in the HMI alarm table
- Monitoring of connected controllers / PLCs possible
- Offline configuration possible

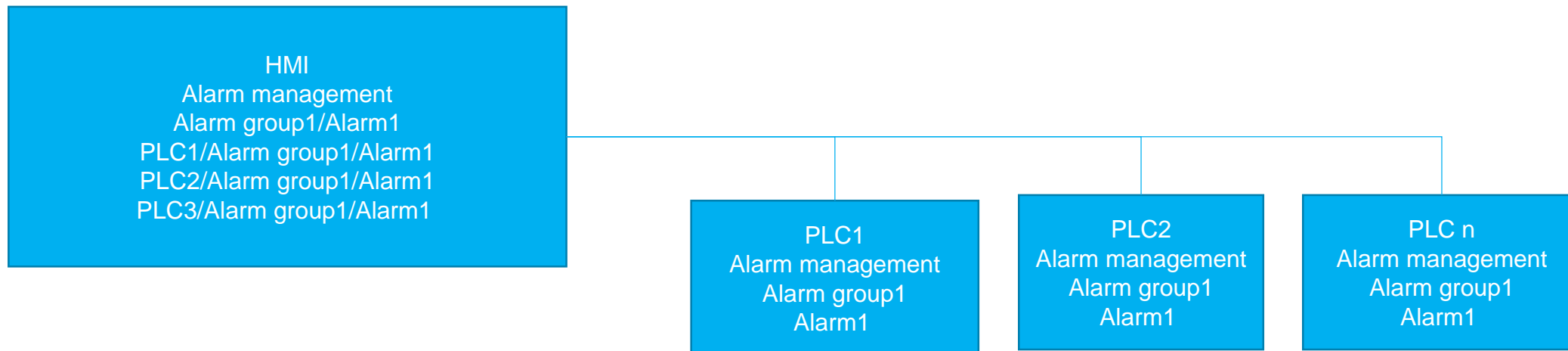
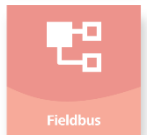
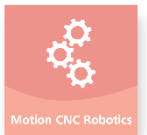
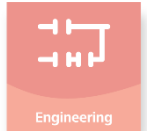

Distributed alarm management for CODESYS HMI

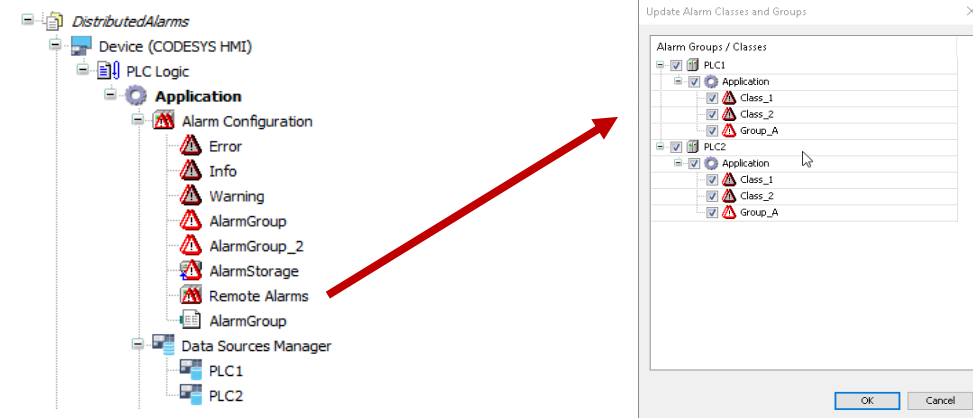
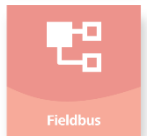
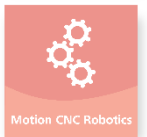

- **Data sources: Provide information on remote alarm groups and classes**
- **New object "Remote Alarms":**
User configuration: Which remote alarm groups and classes are also to be monitored



- **Successfully tested setup:**
 - Limit: 32 controllers / PLCs with 2,000 alarms each
 - Message burst of 1,000 alarms from different controllers: Displayed centrally in the alarm table of the HMI within ~ 1-2 seconds

Alarm table

- Filtering of alarms over time range via IEC variables (data type: DATE_AND_TIME / DT)
- Activation / deactivation of the filtering : via "Filter type"
→ Finding alarms faster

[-] Alarm configuration	
Alarm groups	 All
Priority from	0
Priority to	255
Alarm classes	 All
[-] Filter by latch 1	
Filter variable	HMI_PRG.sFilter
Filter type	HMI_PRG.eFiltType
[-] Filter by time range	
Filter variable, from	HMI_PRG.dtFrom
Filter variable, to	HMI_PRG.dtTo
Filter type	HMI_PRG.eFiltTarget

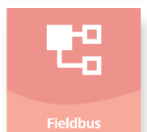
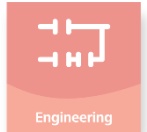

Remote TargetVisu: Extensions

- **Encrypted communication**

- Activation via entry in targetvisuremote.cfg:

```
[CmpVisuHandlerRemote]
Communication.EncryptionMode=1
```

- Installation of the certificate by the following call:
"D:\Presentation\RemoteTargetVisu.exe" --installTrustedCert=D:\Presentation\cert\export\abc.cer

- **Network scan for Linux Remote TargetVisu**

- Already available under Windows/WinCE
- Included in every delivery of the Linux Remote TargetVisu

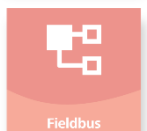
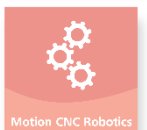
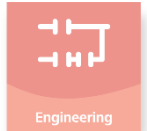
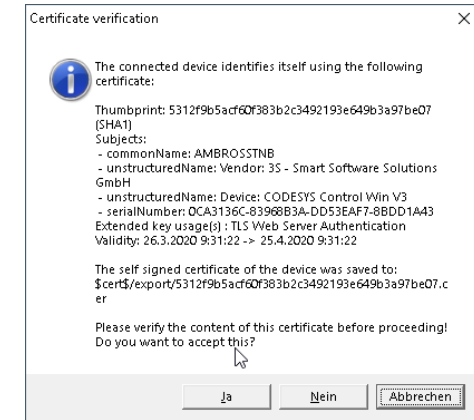

Keyboard operation: Freely configurable tab order

- **Tab sequence independent of element order**
 - Elements removable from tab order
 - Tab order relevant for standard keyboard operation

Type	X	Y	Width	Height	Id	Name	Acce...	Tab Order
#0 Button	10	720	101	30	80	GenEl...		
#1 Button	900	720	101	30	82	GenEl...		3
#2 Spin Box	21	393	55	30	0	GenEl...		6
#3 Spin Box	458	510	55	30	89	GenEl...		1
#4 Group Box	453	60	531	434	90	GenEl...		
#0 Button	153	148	150	30	96	GenEl...		4
#1 Button	153	193	150	30	98	GenEl...		5
#5 Rectangle	10	10	260	30	94	GenEl...		2

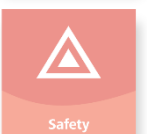
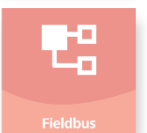
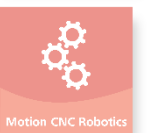
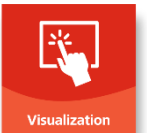
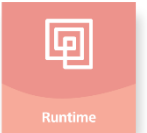
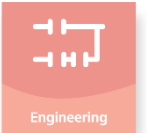

1

Engineering

2

Runtime

3

Visualization

4

Motion CNC Robotics

5

Fieldbus

6

Safety

Overview

- **Basic motion**
- **Multicore support for CNC and robotics**
- **Robotics**

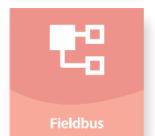
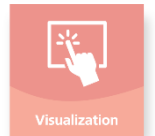
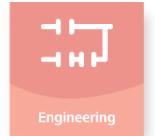

Basic motion: Buffer mode for PLCopen Part 1 FBs

- Single axis FBs like MC_MoveAbsolute as well as Master/Slave FBs like MC_CamIn
- New and easier possibility to command movements one after the other
- New input BufferMode with three modes: Aborting, **Buffered**, **Blending**.

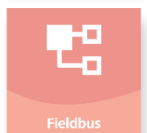
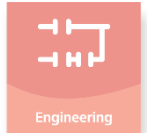
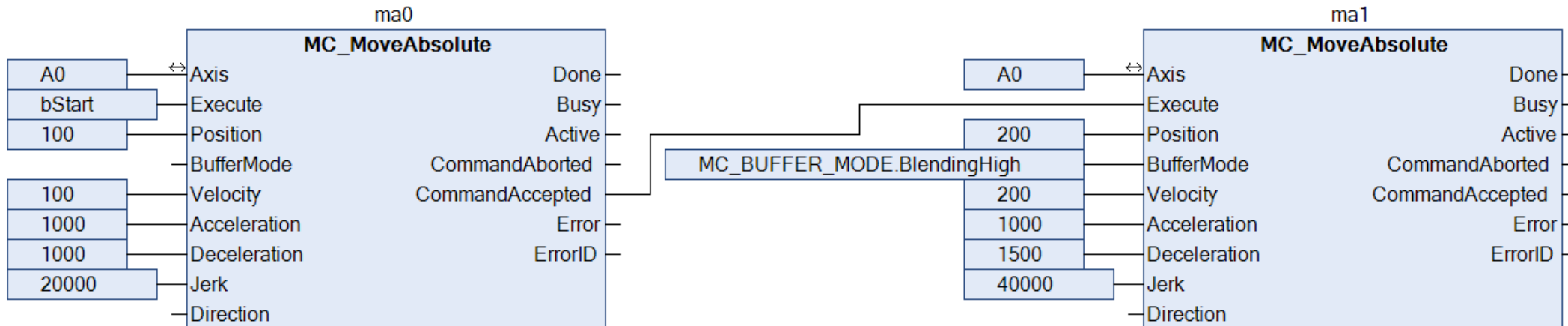

Basic motion: Buffer mode for PLCopen Part 1 FBs

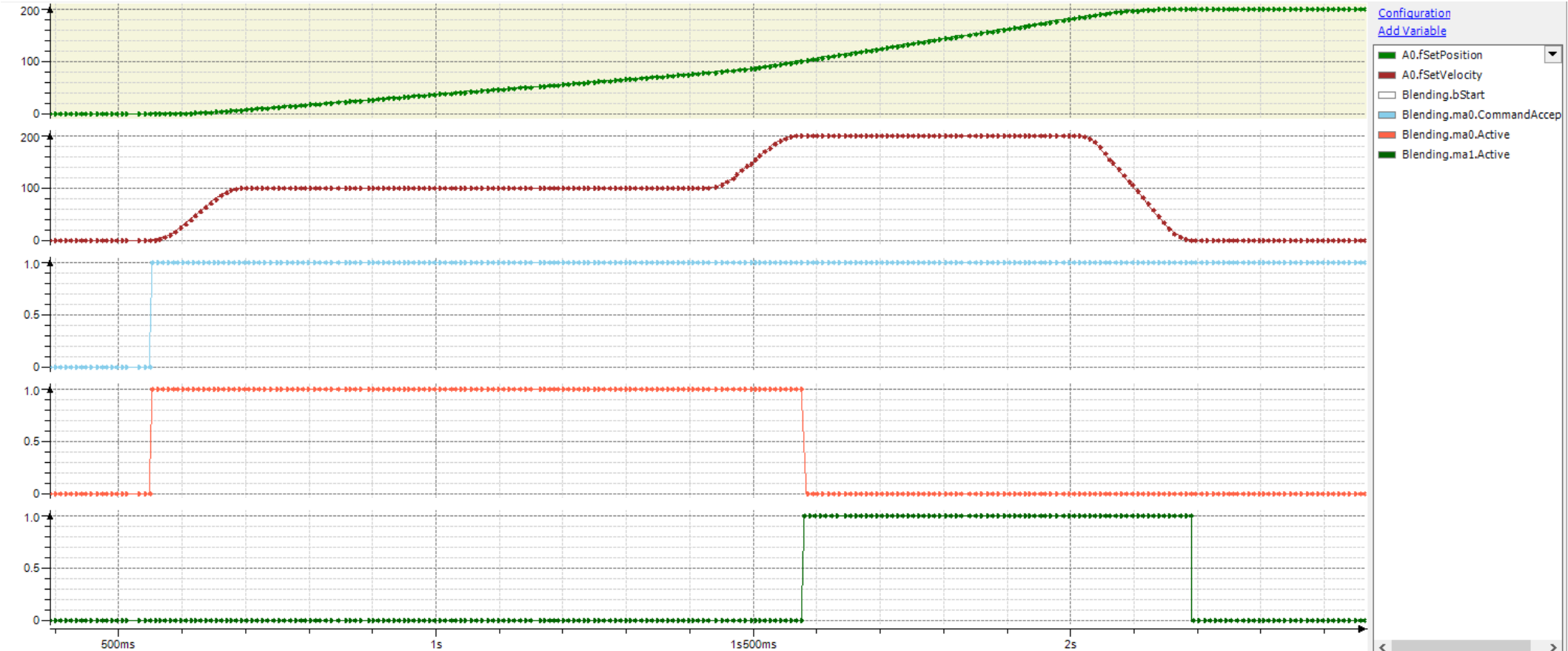

Blending from velocity 100 mm/s to velocity 200 mm/s with mode BlendingHigh at position 100 mm

- Engineering
- Runtime
- Visualization
- Motion CNC Robotics
- Fieldbus
- Safety

Multicore support for CNC and Robotics

- **CNC:**
 - Reading of G code and preprocessing of the path (corner rounding, tool radius correction, ...) on separated core possible
- **Robotics:**
 - Trajectory planning on separate cores possible
 - Flexible distribution of robots among cores possible
- **Significant performance advantages, especially on common Arm/Linux-based PLCs**
(not so powerful, but often with 2 cores)

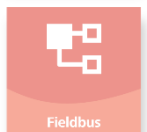

Robotics: Path fidelity during jogging

- New block **SMC_GroupJog2**
- Easier to use (no virtual axes required)
- Moves the robot "true to track" in any case, i.e. on a straight line

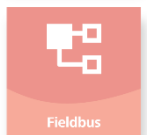
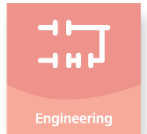
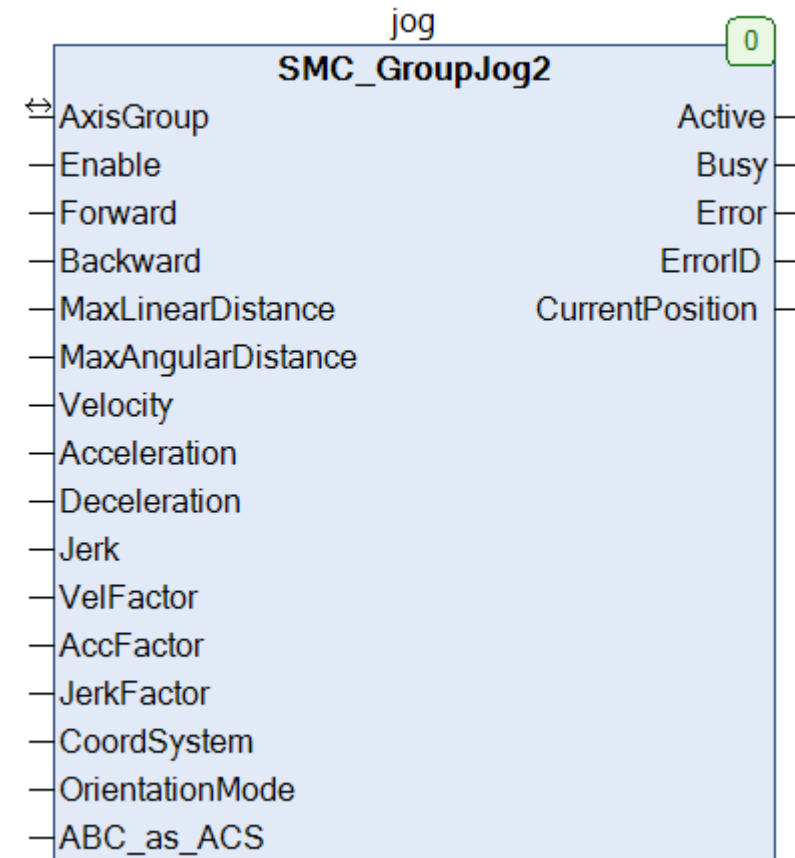

Robotics: Continuing the path

- **Former situation:**
After error of the axis group or after MC_GroupHalt/MC_GroupStop:
all commanded movements removed from axis group
- **New: Optional saving of the status of the axis group, later continuation**
- **Based on MC_GroupContinue**

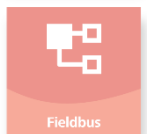
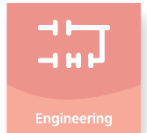
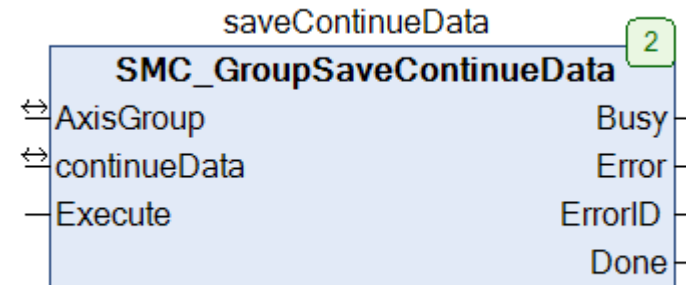
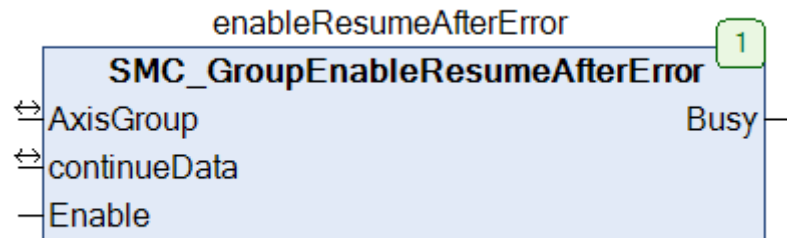

Robotics: Improved movements

- Improved pick & place movements

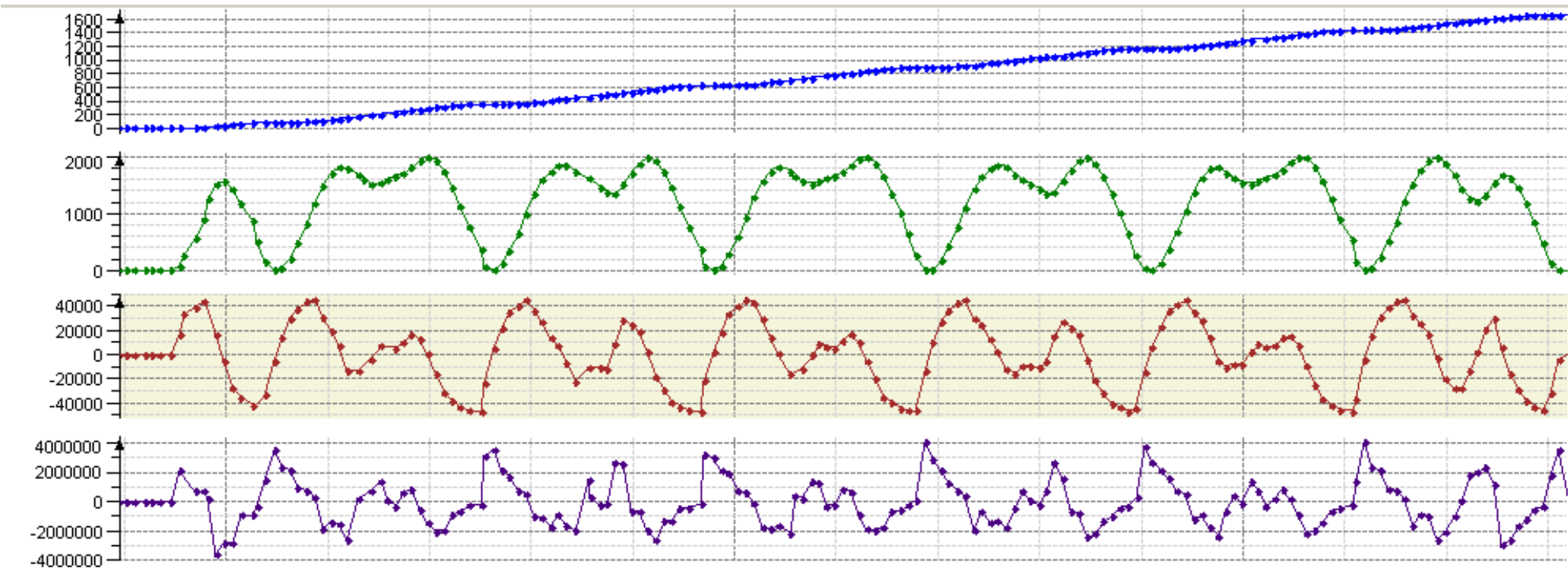

Previous trajectory for a pick & place application
Position (blue), velocity (green), acceleration (red), jerk (violet)

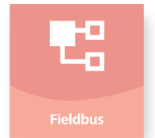
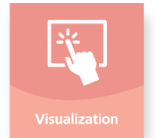
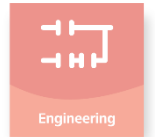

Robotics: Improved movements

- Improved pick & place movements

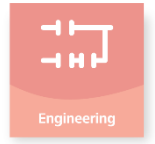
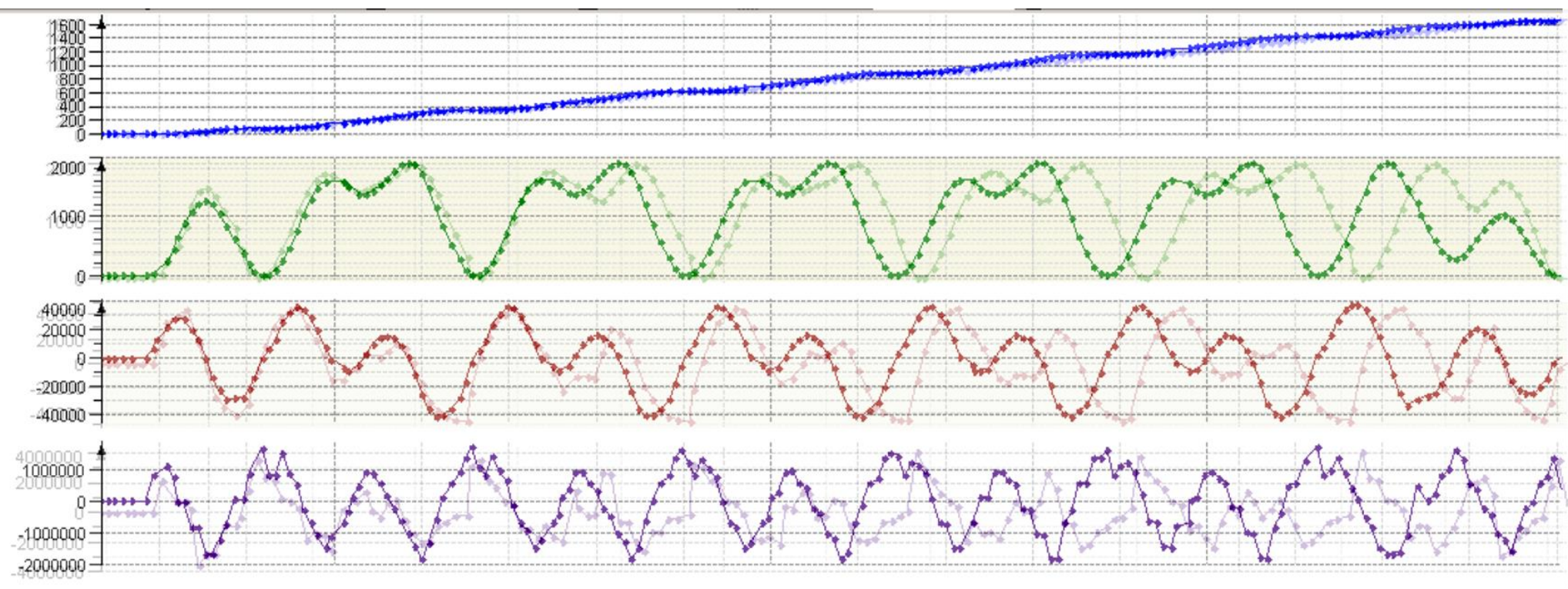

Engineering



Runtime

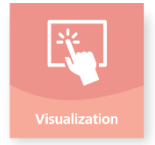

Visualization



Motion CNC Robotics

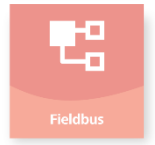

Fieldbus



Safety

Robotics: Improved movements

- Improved pick & place movements
- Improved tracking (synchronization with conveyor belt or rotary table)

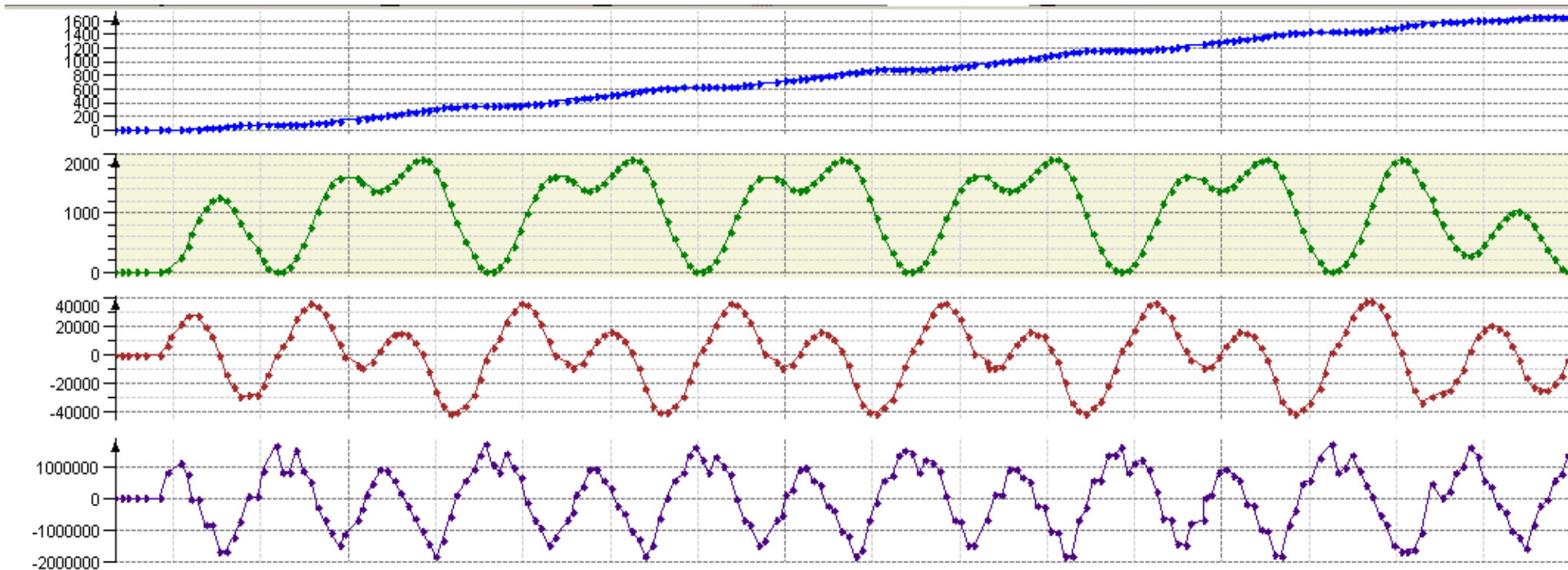

Improved trajectory, compare the red acceleration curve.



Engineering



Runtime



Visualization



Motion CNC Robotics



Fieldbus



Safety

Robotics: Improvements MC_GroupHalt/MC_GroupStop

- Braking ramp starts immediately (previously up to 50 ms delay)
- Set ramp parameters taken into account (previously the ramp of the path was used)

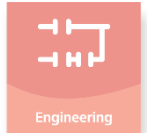
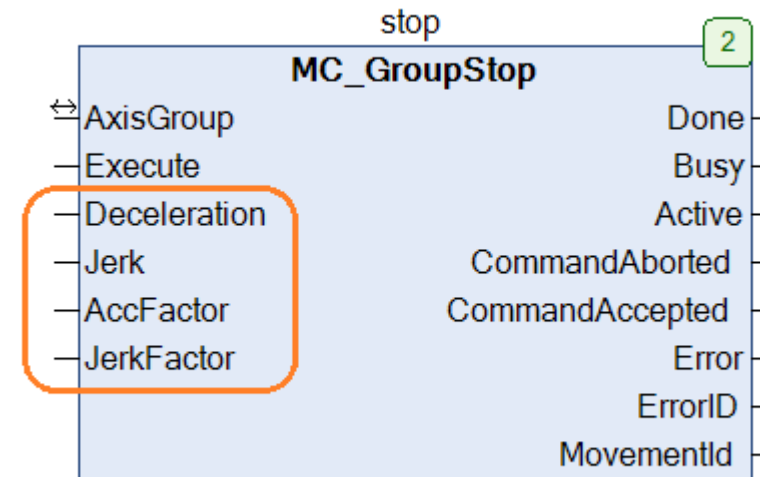

Robotics: Simplified tool change

- New FB for setting a tool
- Terms clarified: tool vs. orientation kinematics

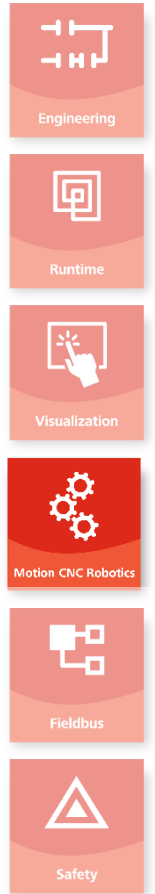
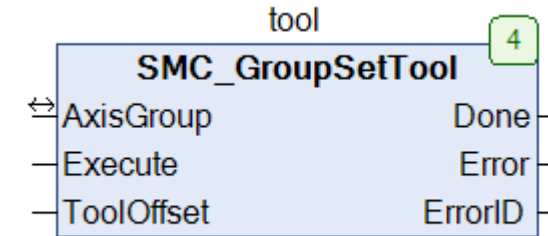
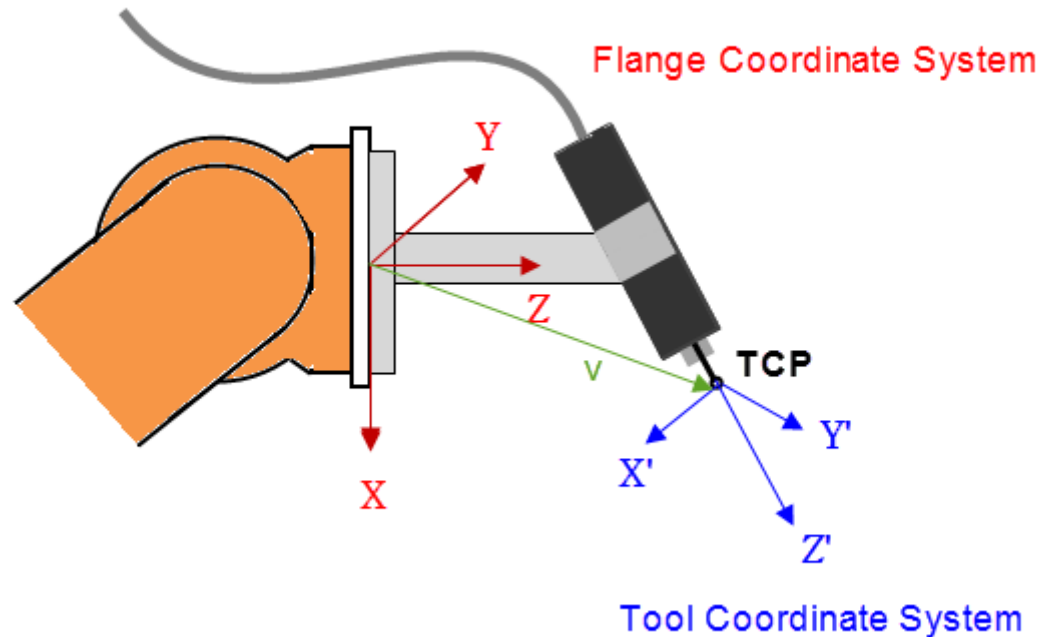

1

Engineering

2

Runtime

3

Visualization

4

Motion CNC Robotics

5

Fieldbus

6

Safety

Overview

- **Diagnosis**
- **Updates of**
 - CODESYS EtherCAT
 - CODESYS PROFINET
 - CODESYS ETHERNET/IP Scanner/Adapter
 - CODESYS CAN
 - CODESYS Modbus
- **Further improvements**

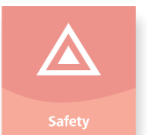
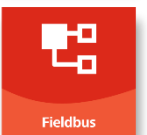
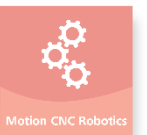
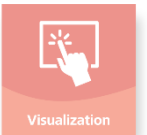
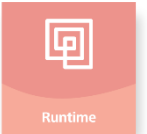
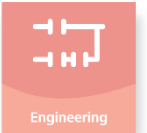

Diagnosis: Recap of SP15

- Error indicator, error cleared and logger page for fieldbus devices

The screenshot displays the CODESYS environment. On the left, the project tree shows the 'CANbus (CANbus)' component highlighted with a red box. Below it, the 'XN_GW_CANOPEN' device is expanded, with its sub-components (Generic_XN_BR/PF, Generic_XN_1AI, Generic_XN_2DO, Generic_XN_1AO, and Generic_XN_2DI) also highlighted with a red box. The main window shows the 'Log' tab selected in the left sidebar, with a red box around the 'Log' button. The log table displays the following entries:

Severity	Time Stamp	Description
Information	26.03.2020 10:53:30.000	NetID 0, NodeID 1: Slave signals CANopen state: OPERATIONAL
Information	26.03.2020 10:53:29.814	NetID 0, NodeID 1: NMT START
Information	26.03.2020 10:53:29.794	NetID 0, NodeID 1: SDO configuration phase finished
Warning	26.03.2020 10:53:29.158	NetID 0, NodeID 1: SDO Write Error for object 16#1014sub00 AbortCode: 16#06090030
Information	26.03.2020 10:53:29.056	NetID 0, NodeID 1: Begin SDO configuration phase... Number of SDOs: 35
Information	26.03.2020 10:53:29.035	NetID 0, NodeID 1: Reading Identity Object 16#1018...
Information	26.03.2020 10:53:29.015	NetID 0, NodeID 1: Reading Device Type (Object 16#1000)...
Information	26.03.2020 10:53:29.015	NetID 0, NodeID 1: Slave signals CANopen state: BOOTUP
Information	26.03.2020 10:53:28.871	NetID 0, NodeID 1: Waiting for Bootup message...
Information	26.03.2020 10:53:28.871	NetID 0, NodeID 1: NMT RESET

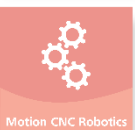

Diagnosis: Status of Implementation SP16

Fieldbus	Logger page	Diagnostic cleared
EtherCAT	X (for Slaves, too)	X
ProfiNet Controller (IEC)	X	X
ProfiNet Controller (NetX)	X	X
ProfiNet Device (IEC)	X	X
ProfiNet Device (NetX)	X	-
Profibus	-	X
Ethernet/IP Scanner (IEC)	X	X
Ethernet/IP Scanner (NetX)	X	X
Ethernet/IP Adapter	X	X
CANopen Master	X	X
CANopen Slave	X	X
J1939	X	X
Sercos	-	-
Modbus TCP/Serial	X	X

Green color: Implemented with SP16

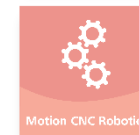
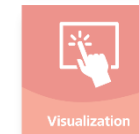
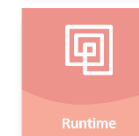
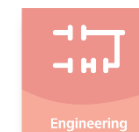

EtherCAT

- Standalone API allows for programmatic fieldbus configuration
 - No master in the device tree necessary
 - Examples available

- Support of Beckhoff AX8xxx drives

Diagnosis

- Status page: Time measurements for SendEthFrame and GetEthFrame

Recv Time (Avg)	LTIME#30us201ns	Average Time for receiving Ethernet Frames per BusCycle
Recv Time (Max)	LTIME#2ms235us600ns	Max Time for receiving Ethernet Frames per BusCycle
Send Time (Avg)	LTIME#45us171ns	Average Time for sending Ethernet Frames per BusCycle
Send Time (Max)	LTIME#335us480ns	Max Time for sending Ethernet Frames per BusCycle

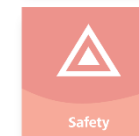
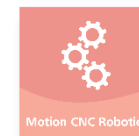
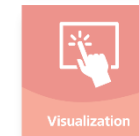
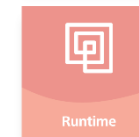
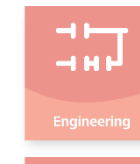

PROFINET controller

- **Reconfigure extensions**
 - Changing IP and station name
 - Reading and changing module settings
- **Less jitter: Reduced semaphore blocking times**
- **MRP Configurator: Configuration of redundant Ethernet ring**

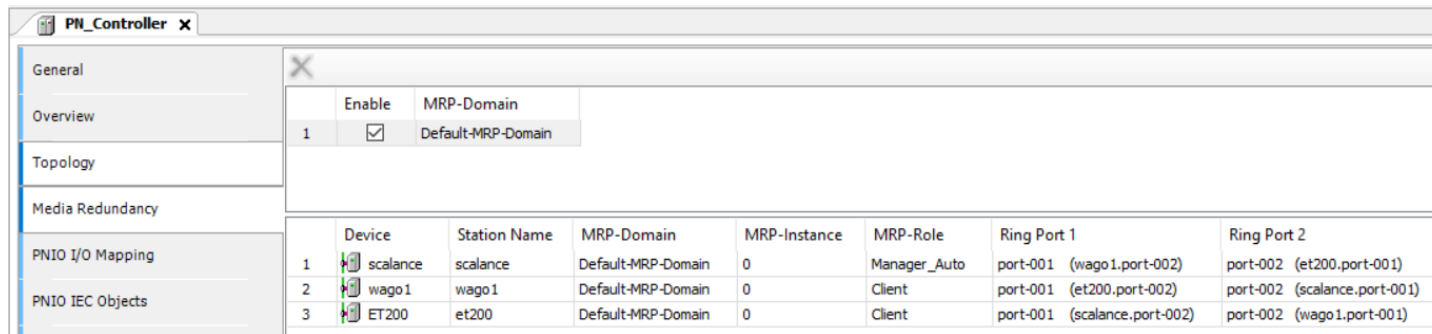

The screenshot shows the 'PN_Controller' configuration window. The 'Media Redundancy' section is active, displaying a table with the following data:

Device	Station Name	MRP-Domain	MRP-Instance	MRP-Role	Ring Port 1	Ring Port 2
1	scalance	Default-MRP-Domain	0	Manager_Auto	port-001 (wago1.port-002)	port-002 (et200.port-001)
2	wago1	Default-MRP-Domain	0	Client	port-001 (et200.port-002)	port-002 (scalance.port-001)
3	ET200	Default-MRP-Domain	0	Client	port-001 (scalance.port-002)	port-002 (wago1.port-001)

- **Configurator: Unicode station names**
- **Diagnosis**
 - Further diagnostic outputs for controller FB

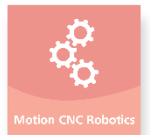
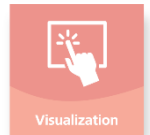
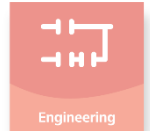

PROFINET Device

- **New FB: DeviceAR-FB**
 - Control all phases of the connection establishment and parameterization

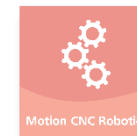
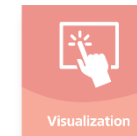
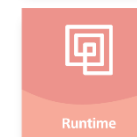
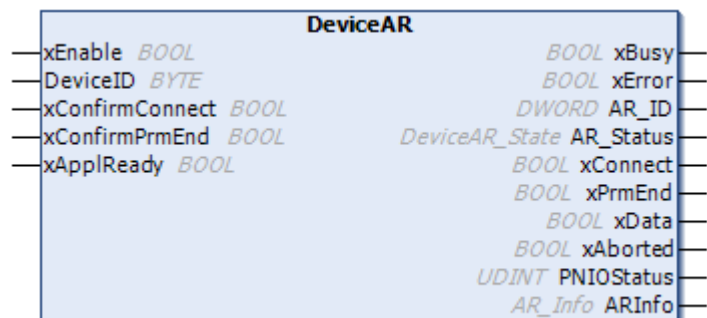

EtherNet/IP: General information

- **Conformance Test**

- First customer with CT16 certification for scanner and adapter (possible from 3.5 SP15 P1)
- As of SP16: CT17 protocol test on Linux successful

- **Significant performance improvement on CODESYS Control RTE with lwIP**

- Average bus cycle time for scanner without slaves, sample measurements:
 - SP15: 4ms
 - SP16: 160us
 → 25 times faster!
- EtherNet/IP test project with test stand, sample measurements:
 - SP15: 16ms
 - SP16: 300us
 → > 50 times faster!

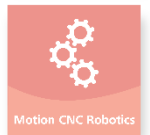
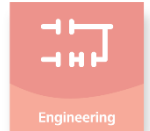

EtherNet/IP

- Scanner:

- Icons: extracted from EDS and displayed

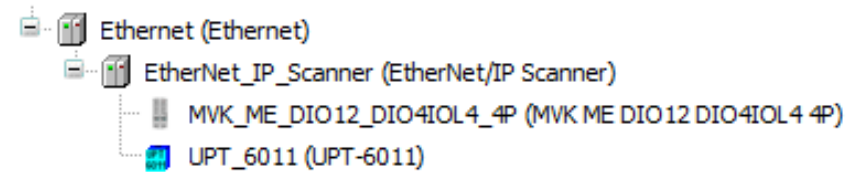

- Adapter:

- Address Conflict Detection (ACD)

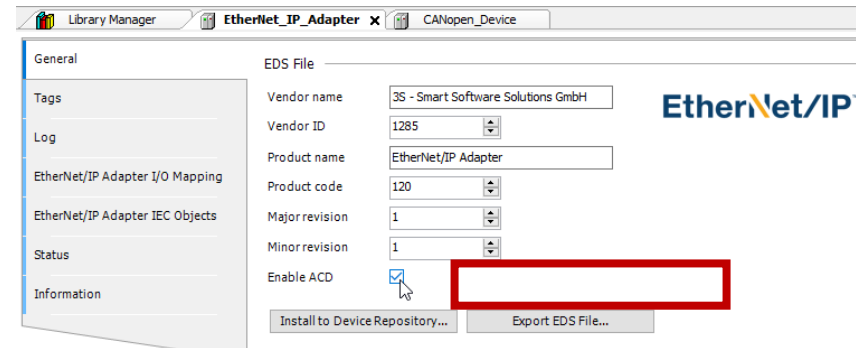

- Support of Connection Tags

General	Connection Name	Transport Type	Connection Path	Connection Tag
Tags	1. Exclusive Owner	Exclusive owner	91 13 61 6C 6C 69 6E 70 75 74 73 61 6E 64 6F 75 74 70 75 74 73 00	AllInputsAndOutputs
Log	2. Input Only	Input only	91 0A 69 6E 70 75 74 73 6F 6E 6C 79	InputsOnly
EtherNet/IP Adapter I/O Mapping	3. Listen Only	Listen only	91 0A 6C 69 73 74 65 6E 6F 6E 6C 79	ListenOnly
EtherNet/IP Adapter IEC Objects	4. Rack Connection	Exclusive owner	20 04 2C 64 2C 65	
Status				
Information				

- New service 'Unconnected Send'

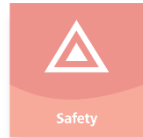
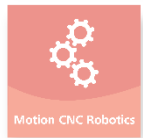
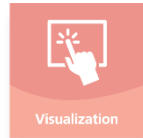
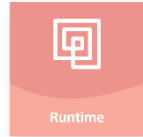

CANopen Master and Slave

- **Various diagnostic enhancements:**
 - Errors in the configuration phase: Displayed as diagnostic messages and in the logger
 - EMCY and abortion codes: Displayed textually
 - Runtime errors: Displayed textually in the logger
 - Diagnostic display: now also with SIL2

☰ ✖	26.03.2020 13:56:40.063	NetID 0, NodeID 1: EMCY Error Code: 16#3320 (Output voltage) Error Register: 16#05 (Generic Error, Voltage) Manufacturer-specific error code: [16#01, 16#01, 16#00, 16#00, 16#00]
ⓘ	26.03.2020 13:54:52.526	NetID 0, NodeID 1: Slave signals CANopen state: OPERATIONAL
ⓘ	26.03.2020 13:54:52.362	NetID 0, NodeID 1: NMT START
ⓘ	26.03.2020 13:54:52.341	NetID 0, NodeID 1: SDO configuration phase finished
☰ ✖	26.03.2020 13:54:51.683	NetID 0, NodeID 1: SDO Write Error for object 16#1014sub00: Invalid value for parameter (download only) Abort code: 16#06090030 Data size: 4 byte(s) Data: [16#81, 16#00, 16#00, 16#80]
☰ ✖	26.03.2020 14:06:42.965	NetID 0: No CAN driver found! (error code: 16#27E2)



J1939

- 64 bit support
- Additional log message for address claiming

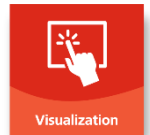

Severity	Time Stamp	Description
	26.03.2020 14:53:17.594	NetID 1, ECU NAME 16#10800A00000 (current address: 0): ECU Address defended against ECU with NAME 16#8000010800A00000.
	26.03.2020 14:53:17.574	NetID 1, ECU NAME 16#10800A00000 (current address: 0): Operational
	26.03.2020 14:53:17.574	NetID 1, ECU NAME 16#10800A00000 (current address: 254): Address claiming in progress...
	26.03.2020 14:53:17.574	NetID 1, ECU NAME 16#10800A00000 (current address: 254): ECU is initializing...

Severity	Time Stamp	Description
	26.03.2020 14:53:18.169	NetID 0, ECU NAME 16#8000010800A00000 (current address: 128): Operational
	26.03.2020 14:53:17.594	NetID 0, ECU NAME 16#8000010800A00000 (current address: 254): Address claiming in progress...
	26.03.2020 14:53:17.594	NetID 0, ECU NAME 16#8000010800A00000 (current address: 254): Address claiming lost against ECU with NAME 16#10800A00000.
	26.03.2020 14:53:17.574	NetID 0, ECU NAME 16#8000010800A00000 (current address: 0): Operational
	26.03.2020 14:53:17.574	NetID 0, ECU NAME 16#8000010800A00000 (current address: 254): Address claiming in progress...
	26.03.2020 14:53:17.574	NetID 0, ECU NAME 16#8000010800A00000 (current address: 254): ECU is initializing...

Modbus

- **Master**

- Better I/O mapping performance through own I/O copy functions (factor 3!)
- Improved diagnostics on status page

- **Slave**

- Modbus TCP Device Extension for RTU Gateway

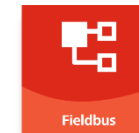
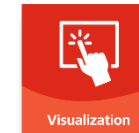
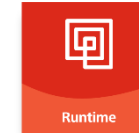
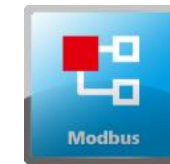

```

Last Error
  Timestamp      DT#2020-3-27-10:3:5
  Channel Index  1
  Error Code     ILLEGAL DATA ADDRESS  Slave does not support this register offset
    
```

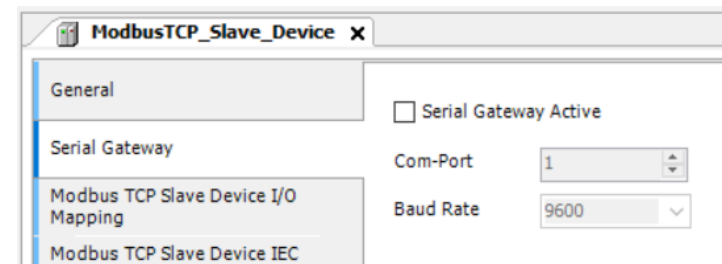

- **Reconfigure: Change serial port settings via application code**

- **Possibility of separating coil and holding registers into different data areas**

Further improvements

- **Device Repository: Reduced memory consumption through hard links**
- **Compile warning: Mapping of wrong variable types**

⚠ C0373: Implicit conversion from unsigned Type 'BYTE' to signed Type 'INT' : Possible change of sign
 ⚠ C0373: Implicit conversion from unsigned Type 'BYTE' to signed Type 'SINT' : Possible change of sign

- **Update device on several devices simultaneously**

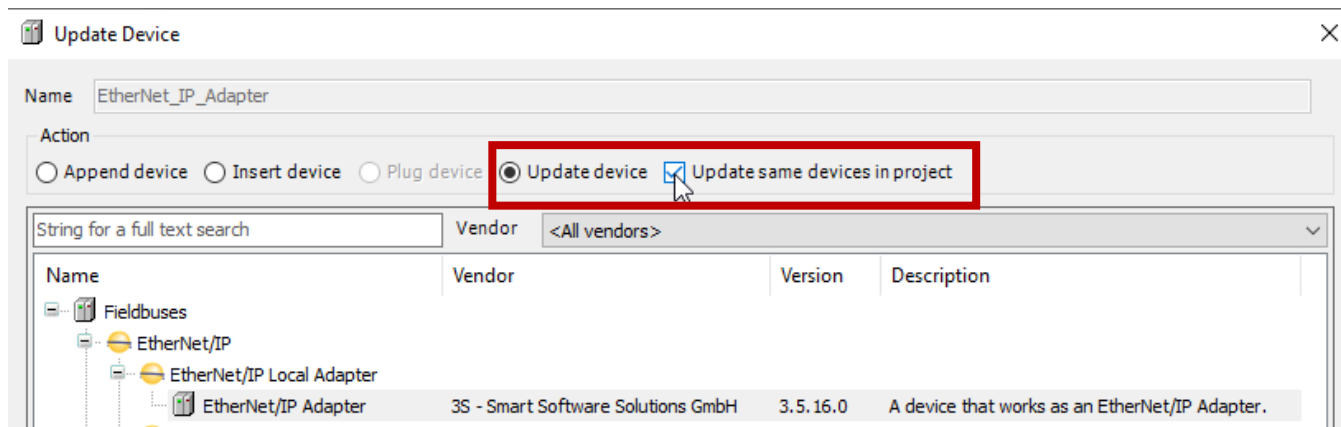

Further improvements

- **Ethernet device**
 - API to change parameters via application code:
 - IP address / subnet mask / gateway address / interface name
- **BACnet**
 - Version 1.5.1 released! Feature Complete
- **PLCNext**
 - Axioline Module Scan
- **Redundancy Editor**
 - Fast switching of the online mode between active and passive PLC

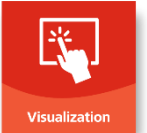
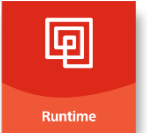
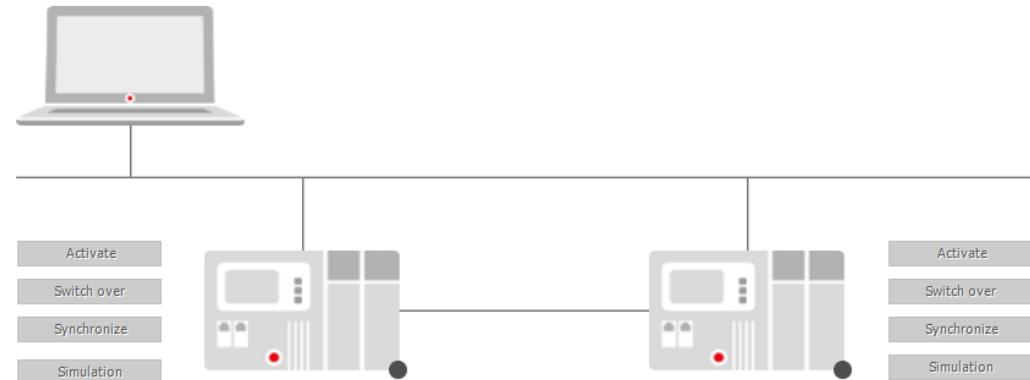
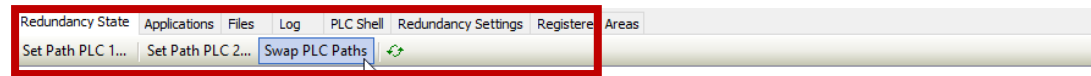

1

Engineering

2

Runtime

3

Visualization

4

Motion CNC Robotics

5

Fieldbus

6

Safety

Overview

- **CODESYS Safety for EtherCAT Safety Modules (4.1.0)**
- **CODESYS Safety Runtime Toolkit / Qualification-Kit (1.6.0)**

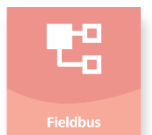
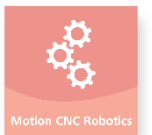
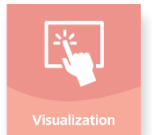
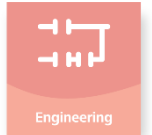

CODESYS Safety for EtherCAT Safety Modules: Process improvement

- **Up to now:**
 - Test on special CODESYS version → Report to TÜV → Release
 - Use with other CODESYS versions: No evaluation / Test / Report to TÜV
- **New: Extended qualification test**
- **New: Information for users**
 - Tab "All Versions" / "Compatibility" on product page in the Store
 - Information update with every successful qualification test
 - User manual: Reference to this information

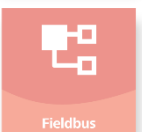
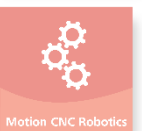
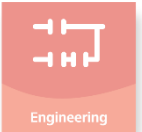

CODESYS Safety for EtherCAT Safety Module (for EL6900) SL

CODESYS extension for EtherCAT based safety solutions with TwinSAFE logic modules EL6900, EL6910 and EK1960 from Beckhoff under a CODESYS controller with CODESYS EtherCAT Master stack.

Version: 4.0.4.0

Order number: 2306000000

Qty: Add to

Download >

[Add to My Wishlist](#) [Recomm](#)

Product Description System Requirements All versions Support More products from this supplier

Version history

Version	Release Notes	Release Date	Compatibility
4.0.4.0	Supported CODESYS version: V3.5 SP14 Patch 3 <ul style="list-style-type: none"> • Support for 10 TwinSAFE SingleChannel analog input modules • Support for FSoE modules with pre-configured SRA-parameters • Support for group deactivation (project configuration) 	27.09.2019	CODESYS V3.5 SP14 Patch 3
4.0.3.0	CODESYS Safety for EtherCAT Safety Module 4.0.3.0 is a	14.03.2018	

CODESYS Safety for EtherCAT Safety Modules: Check of project boundaries

- **Better messages:**
 - E.g. "More than 255 function blocks defined" , or "No function blocks defined"
- **Checked limits for specific derivatives of the EtherCAT Safety modules:**
 - Max. POU's: for EK1960: 128
 - Max. I/O image: for EK1960: 24,576
 - Max. data exchange with non-safety application: Bit limit of 256 / 1024
- **Testing of further limit values:**
 - Unsupported slaves: Too many device-specific parameters, image too large
 - Too many devices with device-specific parameters, too many SC devices
 - Process image too large, too many data points used
 - Too much (monitorable) data in the application

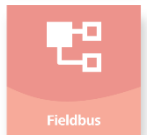
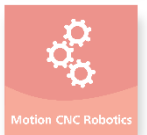
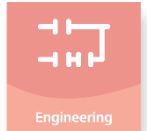

CODESYS Safety for EtherCAT Safety Modules: Faster monitoring cycle

- **So far:**
 - From application data size > 2 kByte
 - Reading of 13 * 2k blocks from controller (via EtherCAT)
 - To ensure complete reading, editor only updated every 2 s(!)
- **New: Editor calculates application data size**
 - Reading only required 2k blocks
 - Update rate accelerated accordingly

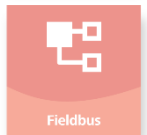
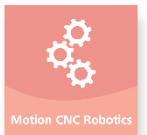

CODESYS Safety for EtherCAT Safety Modules: Support of old projects

- **Manually created device description included for compatible safety modules controllers including onboard IO**
 - Some improvements require a new device description:
E.g. standard EtherCAT diagnostic tab, new driver version for faster monitoring, improved description of device-specific parameters of onboard IOs
- **So far:**
 - Package update: uninstall old device descriptions
 - ➔ Uninstalled device descriptions missing in old projects
 - ➔ Manually perform Update Device command for the controllers
 - ➔ Copy configuration and manual mapping of onboard IOs to new version
(no update device on logical devices)
- **New: Old device descriptions installed additionally ➔ Old projects still work**
- **New: Old projects updateable via Update Environment (incl. onboard IO)**

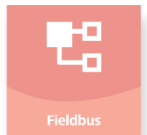
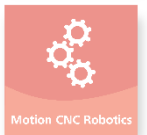
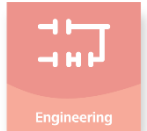

CODESYS Safety Runtime Toolkit / Qualification-Kit: Boot applications

- Up to now: Login with (temporary) download + command “Create bootapplication”
- New: Login download dialog extended by option to create the bootapplication

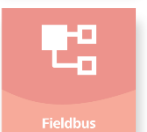
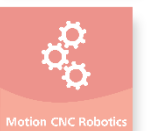
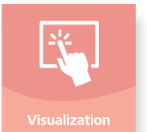
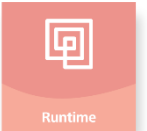
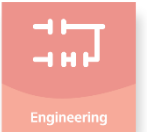
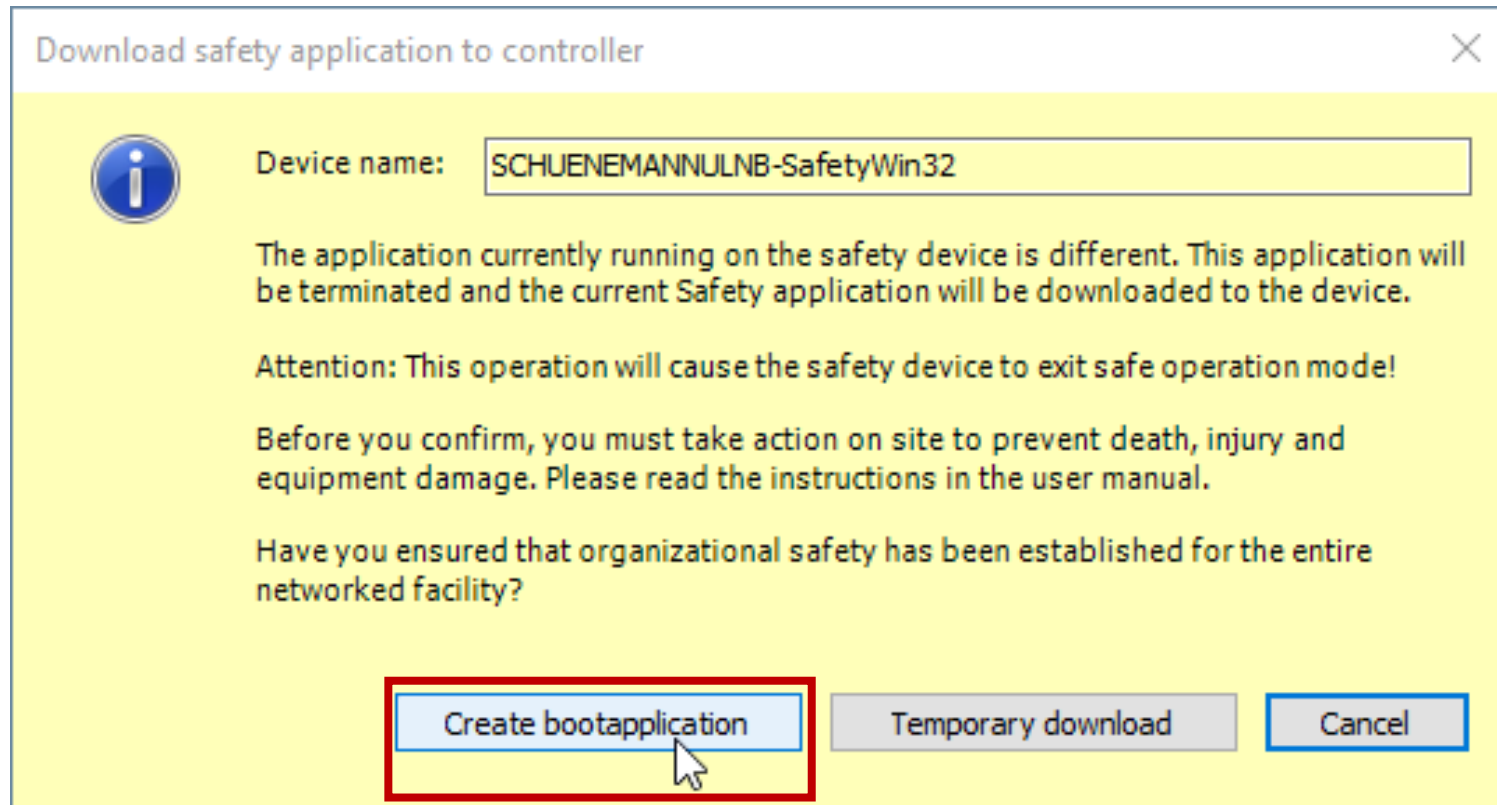

CODESYS Safety Runtime Toolkit / Qualification-Kit: Boot applications

- **Up to now:**
Multiple download not offered for Safety-PLC
- **New: Safety-PLC also selectable for multiple download**
 1. Multiple download selection dialog
 2. Safety dialogs for each Safety PLC, all dialogs carried out in a row in advance
 3. Actual download to selected controllers without safety dialogs
 4. Safety feedback signals per Safety PLC all given in a row at the end
 5. Result overview of the multiple download

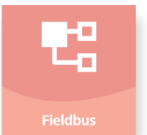
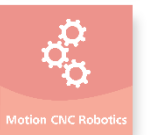
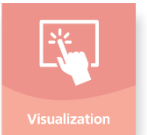
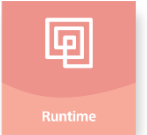



Thank you for your attention!

#stayhealthy

 YouTube

clips.codesys.com

LinkedIn 

CODESYS Group

CODESYS® is a registered trademark. Technical specifications are subject to change.

Errors and omissions excepted. No reproduction or distribution, in whole or in part, without prior permission.

Note: Not all CODESYS features are available in all territories. For more information on geographic restrictions, please contact sales@codesys.com.